

# S.E.5a *ARF*

## INSTRUCTION MANUAL

**ElectriFly™**

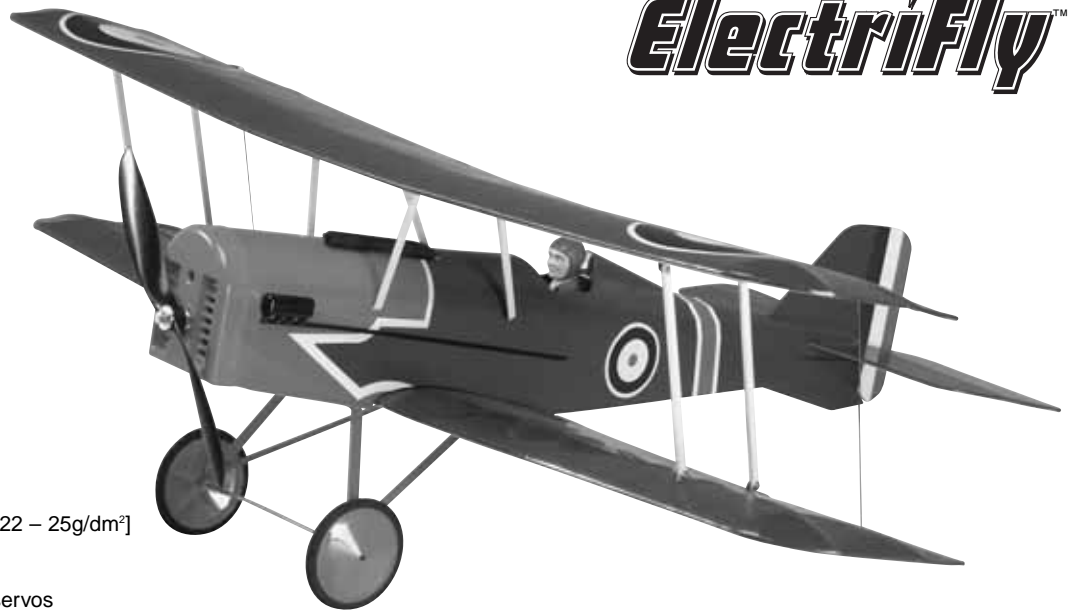

**Wingspan:** 34 in [864mm]

**Wing Area:** 420 sq in [27.1dm<sup>2</sup>]

**Weight:** 1.3 – 1.5 lb [595 – 680g]

**Wing Loading:** 7.5 – 8.2 oz/sq ft [22 – 25g/dm<sup>2</sup>]

**Length:** 25.5 in [648mm]

**Required (not included):**

**Radio:** 4-channel with four micro servos

**Motor:** ElectriFly™ RimFire™ 28-30-950 brushless (not included)

**ESC:** ElectriFly SS-25 (not included)

**Battery:** 11.1V, 1250mAh LiPo

### WARRANTY

**Great Planes® Model Manufacturing Co.** guarantees this kit to be free from defects in both material and workmanship at the date of purchase. This warranty does not cover any component parts damaged by use or modification. **In no case shall Great Planes' liability exceed the original cost of the purchased kit.** Further, Great Planes reserves the right to change or modify this warranty without notice.

In that Great Planes has no control over the final assembly or material used for final assembly, no liability shall be assumed nor accepted for any damage resulting from the use by the user of the final user-assembled product. By the act of using the user-assembled product, the user accepts all resulting liability.

**If the buyer is not prepared to accept the liability associated with the use of this product, the buyer is advised to return this kit immediately in new and unused condition to the place of purchase.**

To make a warranty claim send the defective part or item to Hobby Services at the address below:

Hobby Services  
3002 N. Apollo Dr., Suite 1  
Champaign, IL 61822  
USA

Include a letter stating your name, return shipping address, as much contact information as possible (daytime telephone number, fax number, e-mail address), a detailed description of the problem and a photocopy of the purchase receipt. Upon receipt of the package the problem will be evaluated as quickly as possible.

**READ THROUGH THIS MANUAL BEFORE STARTING CONSTRUCTION. IT CONTAINS IMPORTANT INSTRUCTIONS AND WARNINGS CONCERNING THE ASSEMBLY AND USE OF THIS MODEL.**



Champaign, Illinois  
(217) 398-8970, Ext 5  
[airsupport@greatplanes.com](mailto:airsupport@greatplanes.com)

## TABLE OF CONTENTS

<b>INTRODUCTION</b> .....	2
<b>AMA</b> .....	2
<b>SAFETY PRECAUTIONS</b> .....	2
<b>BATTERY CHARGER OPTIONS</b> .....	3
<b>ADDITIONAL ITEMS REQUIRED</b> .....	3
Hardware & Accessories .....	3
Adhesives & Building Supplies .....	3
Optional Supplies & Tools .....	3
<b>IMPORTANT BUILDING NOTES</b> .....	4
<b>COMMON ABBREVIATIONS</b> .....	4
<b>ORDERING REPLACEMENT PARTS</b> .....	4
<b>METRIC/INCH RULER</b> .....	4
<b>KIT INSPECTION</b> .....	5
<b>KIT CONTENTS</b> .....	5
<b>PREPARATIONS</b> .....	6
<b>ASSEMBLE THE WING</b> .....	6
Install the Ailerons .....	6
<b>ASSEMBLE THE FUSELAGE</b> .....	6
Mount the Wing .....	6
Mount the Stabilizer & Fin .....	7
<b>RADIO INSTALLATION</b> .....	9
Install the Motor & ESC .....	9
Install the Control Horns .....	10
Install the Servos .....	11
Install the Top Wing .....	12
<b>FINISH THE MODEL</b> .....	14
<b>GET THE MODEL READY TO FLY</b> .....	16
Check the Control Directions .....	16
Set the Control Throws .....	16
Balance the Model (C.G.) .....	16
Balance the Model Laterally .....	17
<b>PREFLIGHT</b> .....	17
Identify Your Model .....	17
Charge the Transmitter Batteries .....	17
Balance the Propellers .....	17
Proper Care of Your Motor .....	18
Ground Check .....	18
Range Check .....	18
<b>MOTOR &amp; BATTERY SAFETY PRECAUTIONS</b> .....	18
<b>AMA SAFETY CODE (excerpts)</b> .....	18
<b>CHECK LIST</b> .....	19
<b>FLYING</b> .....	19
Takeoff .....	19
Flight .....	20
Landing .....	20

## INTRODUCTION

The S.E.5a is one of the most recognizable and popular of all the WW1 Biplanes. You can now have this great looking and flying aircraft as an electric without the mess and fuss of a glow engine. With today's LiPo batteries and micro servos, small electrics have become very popular. Now Great Planes brings you the S.E.5a in a small, easy to fly,

ARF electric. So if you want to impress your glow flying buddies with an electric, the Great Planes S.E.5a EP ARF is just what you need.

For the latest technical updates or manual corrections to the S.E.5a EP ARF, visit the Great Planes web site at **www.greatplanes.com**. Open the "Airplanes" link and select the S.E.5a EP ARF. If there is new technical information or changes to this model a "tech notice" box will appear in the upper left corner of the page.

## AMA

We urge you to join the AMA (Academy of Model Aeronautics) and a local R/C club. The AMA is the governing body of model aviation and membership is required to fly at AMA clubs. Though joining the AMA provides many benefits, one of the primary reasons to join is liability protection. Coverage is not limited to flying at contests or on the club field. It even applies to flying at public demonstrations and air shows. Failure to comply with the Safety Code (excerpts printed in the back of the manual) may endanger insurance coverage. Additionally, training programs and instructors are available at AMA club sites to help you get started the right way. There are over 2,500 AMA chartered clubs across the country. Contact the AMA at the address or toll-free phone number below.



**Academy of Model Aeronautics**  
5151 East Memorial Drive  
Muncie, IN 47302  
Tele: (800) 435-9262  
Fax (765) 741-0057  
Or via the Internet at:  
<http://www.modelaircraft.org>

**IMPORTANT!!!** Two of the most important things you can do to preserve the radio controlled aircraft hobby are to avoid flying near full-scale aircraft and avoid flying near or over groups of people.

## PROTECT YOUR MODEL, YOURSELF & OTHERS...FOLLOW THESE IMPORTANT SAFETY PRECAUTIONS

1. Your S.E.5a EP ARF should not be considered a toy, but rather a sophisticated, working model that functions very much like a full-size airplane. Because of its performance capabilities, the S.E.5a EP ARF, if not assembled and operated correctly, could possibly cause injury to yourself or spectators and damage to property.

2. You must assemble the model **according to the instructions**. Do not alter or modify the model, as doing so may result in an unsafe or unflyable model. In a few cases the instructions may differ slightly from the photos. In those instances the written instructions should be considered as correct.

3. You must take time to **build straight, true and strong**.

4. You must use an R/C radio system that is in first-class condition.

5. You must correctly install all R/C and other components so that the model operates correctly on the ground and in the air.

6. You must check the operation of the model before **every** flight to insure that all equipment is operating and that the model has remained structurally sound. Be sure to check clevises or other connectors often and replace them if they show any signs of wear or fatigue.

7. If you are not an experienced pilot or have not flown this type of model before, we recommend that you get the assistance of an experienced pilot in your R/C club for your first flights. If you're not a member of a club, your local hobby shop has information about clubs in your area whose membership includes experienced pilots.

We, as the kit manufacturer, provide you with a top quality, thoroughly tested kit and instructions, but ultimately the quality and flyability of your finished model depends on how you build it; therefore, we cannot in any way guarantee the performance of your completed model, and no representations are expressed or implied as to the performance or safety of your completed model.

**Remember: Take your time and follow the instructions to end up with a well-built model that is straight and true.**

## BATTERY CHARGER OPTIONS

The Great Planes S.E.5a EP ARF is designed for use with LiPo batteries only. All LiPo batteries require a charger specifically designed for charging LiPo batteries. The use of a charger not designed for charging LiPo batteries will result in damage to the batteries and possibly a fire.

We recommend the use of the Great Planes Triton™ DC Peak Charger (GPMM3150), the ElectriFly™ DC PolyCharge™ (GPMM3010) or for charging more than one battery at a time the ElectriFly PolyCharge4 (GPMM3015).

## ADDITIONAL ITEMS REQUIRED

### Hardware & Accessories

In addition to the items listed in the “**BATTERY CHARGER OPTIONS**” section, the following is the list of hardware and accessories required to finish the S.E.5a EP ARF. Order numbers are provided in parentheses.

- 4-Channel radio with four micro servos
- (1) ElectriFly SS-25 25 amp brushless ESC (GPMM1820)
- (1) ElectriFly 3.5mm Bullet™ (male) to 2mm Bullet (female) connector adapter (GPMM3122)
- (1) ElectriFly 1250mAh LiPo 3-cell battery (GPMP0823)
- (1) Futaba® R114F 4-channel FM receiver (FUTL0443, FUTL0442)
- (2) 12" [305mm] Futaba extensions (FUTM4507)
- (1) Futaba “Y-harness” (FUTM4130)
- (1) ElectriFly RimFire C28-30-950 brushless motor (GPMG4560)
- (1) 10x4.5 Prop (GPMQ6660)
- (1) 3mm Prop adapter (GPMQ4959)

### Adhesives & Building Supplies

In addition to common household tools and hobby tools, this is the “short list” of the most important items required to build the S.E.5a EP ARF. **Great Planes Pro™ CA and Epoxy glue are recommended.**

- 1 oz. [28g] Thin Pro CA (GPMR6002)
- #1 Hobby knife (HCAR0105)
- #11 Blades (5-pack, HCAR0211)
- Medium T-pins (100, HCAR5150)
- Builder's Triangle Set (HCAR0480)
- K & S #801 Kevlar® thread or string (for stab alignment)
- Pliers
- Wire cutter
- Top Flite® MonoKote® heat gun (TOPR2000)
- Clear tape

### Optional Supplies & Tools

Here is a list of optional tools mentioned in the manual that will help you build the S.E.5a EP ARF.

- Stick-on segmented lead weights (GPMQ4485)
- Top Flite MonoKote sealing iron (TOPR2100)
- Top Flite Hot Sock™ iron cover (TOPR2175)
- 2 oz. [57g] Spray CA activator (GPMR6035)
- CA applicator tips (HCAR3780)
- CA debonder (GPMR6039)
- Robart Super Stand II (ROBP1402)
- CG Machine™ (GPMR2400)
- Precision Magnetic Prop Balancer™ (TOPQ5700)

## IMPORTANT BUILDING NOTES

- When you see the term **test fit** in the instructions, it means that you should first position the part on the assembly **without using any glue**, and then slightly modify or *custom fit* the part as necessary for the best fit.
- **Photos** and **sketches** are placed **before** the step they refer to. Frequently you can study photos in following steps to get another view of the same parts.
- The stabilizer and wing incidences and motor thrust angles have been factory-built into this model. However, some technically-minded modelers may wish to check these measurements anyway. To view this information visit the web site at [www.greatplanes.com](http://www.greatplanes.com) and click on "Technical Data." Due to manufacturing tolerances which will have little or no effect on the way your model will fly, please expect slight deviations between your model and the published values.

## COMMON ABBREVIATIONS

- Fuse = Fuselage
- Stab = Horizontal Stabilizer
- Fin = Vertical Fin
- LE = Leading Edge
- TE = Trailing Edge
- LG = Landing Gear
- Ply = Plywood
- " = Inches
- mm = Millimeters
- ESC = Electronic Speed Control

## ORDERING REPLACEMENT PARTS

Replacement parts for the Great Planes S.E.5a EP ARF are available using the order numbers in the **Replacement Parts List** that follows. The fastest, most economical service can be provided by your hobby dealer or mail-order company.

To locate a hobby dealer, visit the Hobbico® web site at [www.hobbico.com](http://www.hobbico.com). Choose "Where to Buy" at the bottom of the menu on the left side of the page. Follow the instructions provided on the page to locate a U.S., Canadian or International dealer.

Parts may also be ordered directly from Hobby Services by calling (217) 398-0007, or via facsimile at (217) 398-7721, but full retail prices and shipping and handling charges will apply. Illinois and Nevada residents will also be charged sales tax. If ordering via fax, include a Visa® or MasterCard® number and expiration date for payment.

Mail parts orders and payments by personal check to:

Hobby Services  
3002 N. Apollo Drive, Suite 1  
Champaign, IL 61822

Be certain to specify the order number exactly as listed in the **Replacement Parts List**. Payment by credit card or personal check only; no C.O.D.

If additional assistance is required for any reason contact Product Support by e-mail at [productsupport@greatplanes.com](mailto:productsupport@greatplanes.com), or by telephone at (217) 398-8970.

Description	How to Purchase
Missing pieces	Contact Product Support
Instruction manual	Contact Product Support
Kit parts listed below	Hobby Supplier

### Replacement Parts List

- GPMA3000 .....Upper Wing Set
- GPMA3001 .....Lower Wing Set
- GPMA3002 .....Fuse Set
- GPMA3003 .....Tail Surface Set
- GPMA3004 .....Cowl
- GPMA3005 .....Cabanes Set
- GPMA3006 .....Interplane Set
- GPMA3007 .....Machine Gun Set
- GPMA3008 .....Exhaust Stack Set
- GPMA3009 .....Landing Gear
- GPMA3010 .....Wheels (2)
- GPMA3011 .....Pilot

**To convert inches to millimeters, multiply inches by 25.4**

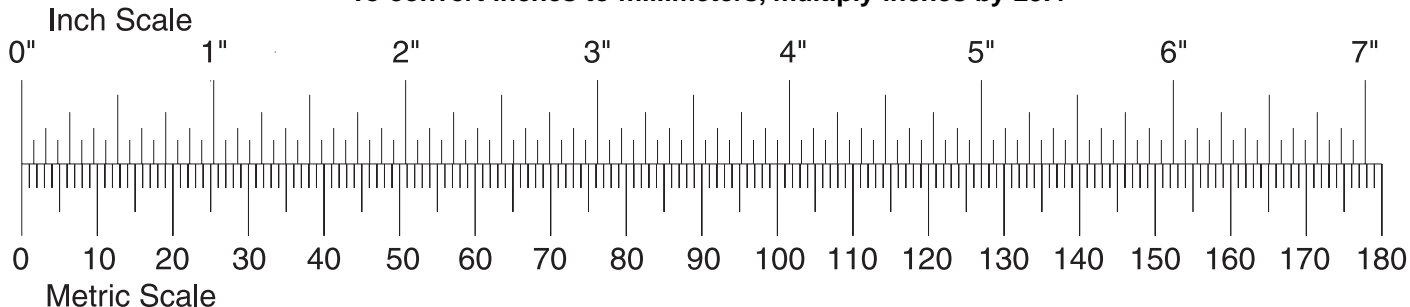

## KIT INSPECTION

Before starting to build, take an inventory of this kit to make sure it is complete, and inspect the parts to make sure they are of acceptable quality. If any parts are missing or are not of acceptable quality, or if you need assistance with assembly, contact **Product Support**. When reporting defective or missing parts, use the part names exactly as they are written in the Kit Contents list.

**Great Planes Product Support**  
 3002 N. Apollo Drive, Suite 1  
 Champaign, IL 61822  
 Telephone: (217) 398-8970, ext. 5  
 Fax: (217) 398-7721  
 E-mail: [airsupport@greatplanes.com](mailto:airsupport@greatplanes.com)

## KIT CONTENTS

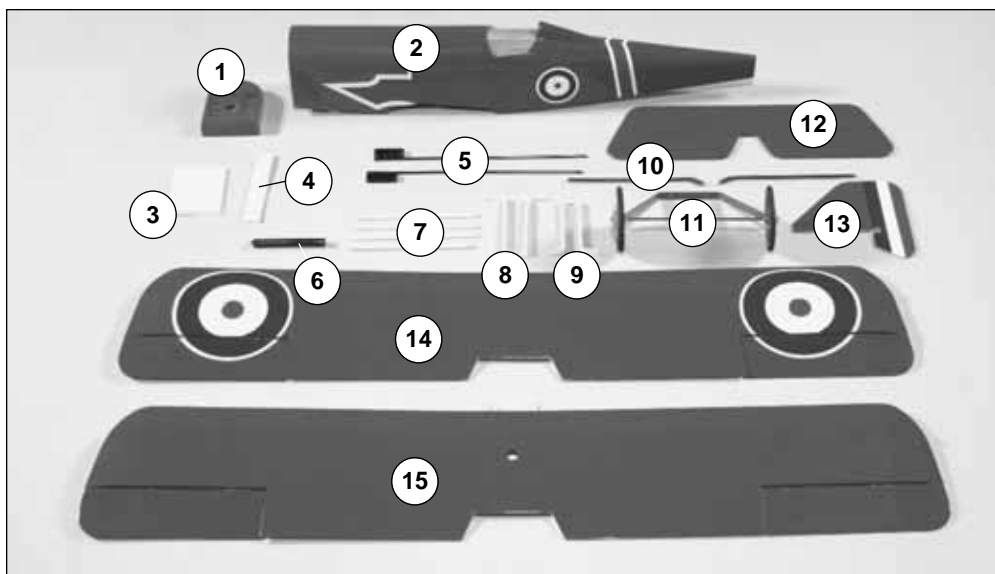

### Kit Contents (photographed)

- |                                                                                                                                                                                                         |                                                                                                                                                                                                                                                                  |                                                                                                                       |
|---------------------------------------------------------------------------------------------------------------------------------------------------------------------------------------------------------|------------------------------------------------------------------------------------------------------------------------------------------------------------------------------------------------------------------------------------------------------------------|-----------------------------------------------------------------------------------------------------------------------|
| <ul style="list-style-type: none"> <li>1. Radiator</li> <li>2. Fuselage</li> <li>3. Battery Hatch</li> <li>4. Hook &amp; Loop Material</li> <li>5. Exhaust (L&amp;R)</li> <li>6. Machine Gun</li> </ul> | <ul style="list-style-type: none"> <li>7. Outer Wing Struts (2 long, 2 short)</li> <li>8. Long Cabanes (2)</li> <li>9. Short Cabanes (2)</li> <li>10. Landing Gear Supports (2)</li> <li>11. Main Landing Gear</li> <li>12. Stabilizer &amp; Elevator</li> </ul> | <ul style="list-style-type: none"> <li>13. Fin &amp; Rudder</li> <li>14. Top Wing</li> <li>15. Bottom Wing</li> </ul> |
|---------------------------------------------------------------------------------------------------------------------------------------------------------------------------------------------------------|------------------------------------------------------------------------------------------------------------------------------------------------------------------------------------------------------------------------------------------------------------------|-----------------------------------------------------------------------------------------------------------------------|

### Kit Contents (not photographed)

- |                                                                                                                                                                                                                                                                                                                                                                                                                |                                                                                                                                                                                                                                                                                                                                                                                                                      |                                                                                                                                                                                                                                                                            |
|----------------------------------------------------------------------------------------------------------------------------------------------------------------------------------------------------------------------------------------------------------------------------------------------------------------------------------------------------------------------------------------------------------------|----------------------------------------------------------------------------------------------------------------------------------------------------------------------------------------------------------------------------------------------------------------------------------------------------------------------------------------------------------------------------------------------------------------------|----------------------------------------------------------------------------------------------------------------------------------------------------------------------------------------------------------------------------------------------------------------------------|
| <ul style="list-style-type: none"> <li>(3) 3 x 6mm Machine Screws</li> <li>(8) 2 x 7mm Self-Tapping Screws</li> <li>(4) 35mm Aileron Pushrod</li> <li>(4) 25mm Heat-Shrink Tubing</li> <li>(4) #1 Strut Mounts</li> <li>(2) #2 Strut Mounts</li> <li>(2) #3 Strut Mounts</li> <li>(1) Plywood Motor Mount</li> <li>(3) Aluminum Tubes</li> <li>(3) 3 x 26mm Machine Screws</li> <li>(7) 3mm Washers</li> </ul> | <ul style="list-style-type: none"> <li>(2) 460mm Pushrods</li> <li>(4) Control Horns</li> <li>(2) Screw-Lock Pushrod Connectors</li> <li>(2) Screw-Lock Nylon Retainers</li> <li>(1) Double-Sided Tape</li> <li>(2) Aileron Servo Hatch</li> <li>(1) 3 x 18mm Machine Screw</li> <li>(4) Straight Control Horn</li> <li>(1) Hook &amp; Loop Material</li> <li>(14) 2 x 8mm Self-Tapping Washer Head Screw</li> </ul> | <ul style="list-style-type: none"> <li>(2) 100mm Pushrod Z-Bend One End</li> <li>(2) 100mm Pushrod L-Bend One End</li> <li>(2) Plastic Pushrod Retainer</li> <li>(2) 2 x 9mm Machine Screw</li> <li>(2) 2mm Washer</li> <li>(2) 2 x 5mm Flat Head Machine Screw</li> </ul> |
|----------------------------------------------------------------------------------------------------------------------------------------------------------------------------------------------------------------------------------------------------------------------------------------------------------------------------------------------------------------------------------------------------------------|----------------------------------------------------------------------------------------------------------------------------------------------------------------------------------------------------------------------------------------------------------------------------------------------------------------------------------------------------------------------------------------------------------------------|----------------------------------------------------------------------------------------------------------------------------------------------------------------------------------------------------------------------------------------------------------------------------|

## PREPARATIONS

❑ 1. If you have not done so already, remove the major parts of the kit from the box (wing, fuselage, tail parts, etc.) and inspect them for damage. If any parts are damaged or missing, contact **Product Support** at the address or telephone number on page 5.

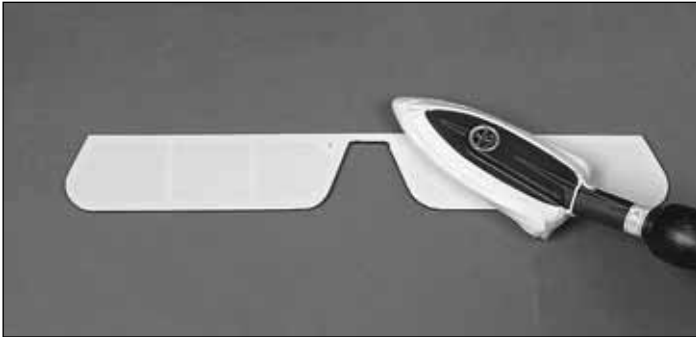

❑ 2. Separate the ailerons from the wing, the rudder from the fin and the elevator from the stabilizer. If necessary, use a covering iron set on medium/high to carefully tighten the covering. Lay the control surface on a flat surface and apply pressure over sheeted areas to **thoroughly** bond the covering to the wood. **Hint:** Poke three or four pin holes in the covering over the open structure in the tail surfaces. This will allow the hot air to escape while tightening the covering.

**Warning: Do not over shrink the covering or it will cause the control surfaces to twist.**

## ASSEMBLE THE WING

### Install the Ailerons

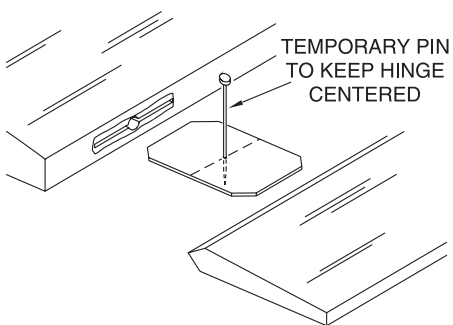

❑ ❑ 1. Test fit the right aileron to the bottom wing with two 6.4 x 15mm hinges. If the hinges don't stay centered, stick a pin through the middle of the hinges to hold them in position while fitting the aileron to the wing.



❑ ❑ 2. Remove any pins you may have inserted into the hinges. Adjust the aileron so there is a very small gap between the LE of the aileron and the wing. The gap should be small – just enough to see light through or to slip a piece of paper through.

❑ ❑ 3. Apply three drops of thin CA to the top and bottom of each hinge. Do not use CA accelerator. After the CA has cured, test the hinges by pulling on the ailerons.

❑ 4. Now join the other aileron to the bottom wing using the same procedure.

❑ 5. Repeat the process of installing the ailerons on the top wing.

## ASSEMBLE THE FUSELAGE

### Mount the Wing

❑ 1. Trim the covering from the bolt hole at the TE of the bottom wing.

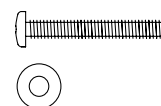
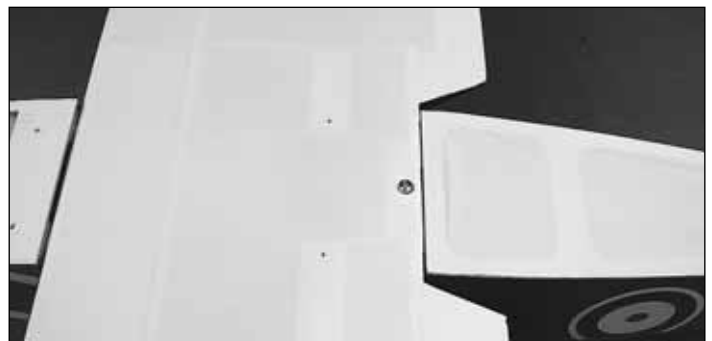

❑ 2. Test fit the wing to the fuselage and bolt it into position with a 3 x 18mm machine screw and 3mm washer.

## Mount the Stabilizer & Fin

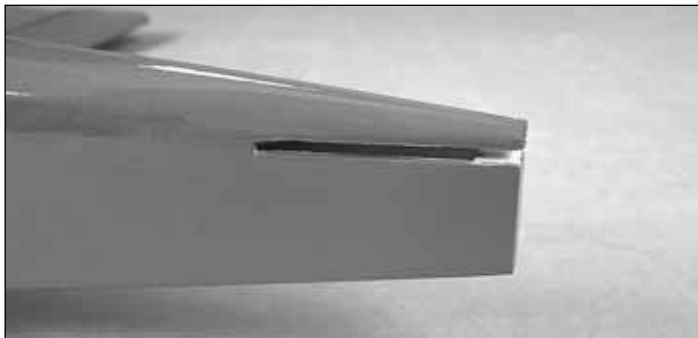

❑ 1. Using a sharp hobby knife, remove the covering from the stabilizer slot at the aft end of the fuselage. Also remove the temporary balsa block.



❑ 2. Mark the center of the TE of the stabilizer. Insert the stabilizer into the slot.

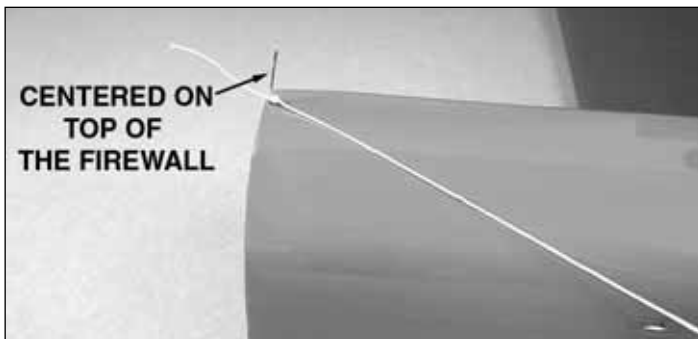

❑ 3. Stick a T-pin into the center of the top of the firewall. Tie a small loop in one end of a 900mm piece of non-elastic string such as K&S #801 Kevlar thread. Slip the loop in the string over the T-pin.

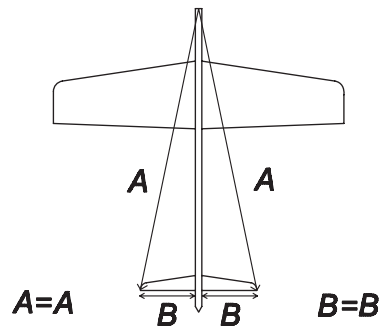
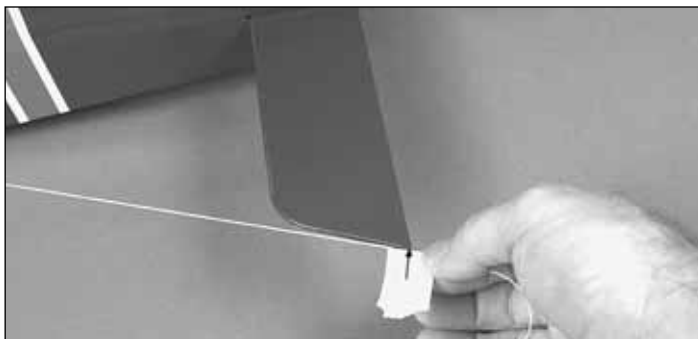

❑ 4. Fold a piece of masking tape over the other end of the string and draw an arrow on it. With the stab centered on the fuselage and the TE of the stabilizer flush with the aft end of the fuse, slide the tape along the string and align the arrow with one tip of the stab. Swing the string over to the same position at the other end of the stab. If the arrow doesn't align with the tip, adjust the stab and the arrow slightly and check both tips again. Adjust the stab until the stabilizer tips and the TE are centered.

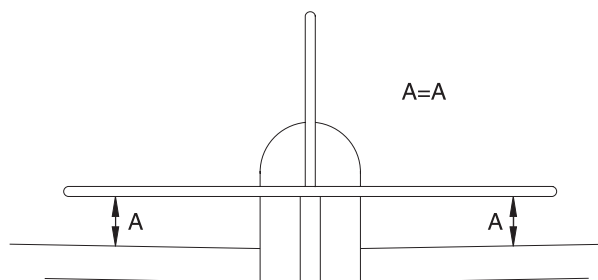

❑ 5. View the stab from approximately 3m behind the plane. Check that the stab is parallel with the wing. If it is not, lightly sand the stab saddle until the stab is parallel with the wing.

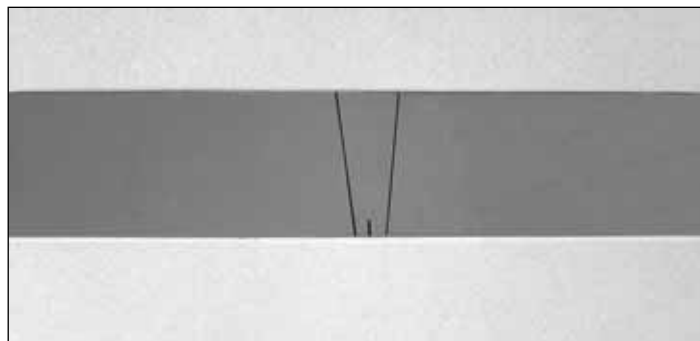

❑ 6. Use a fine-point felt-tip pen to mark the outline of the fuselage onto the bottom and top of the stab.

❑ 7. Remove the stab from the fuselage. Use a sharp #11 hobby knife or the "Expert Tip" that follows to cut the covering from the stab just inside the lines you marked. Use care to cut **only the covering** and not the wood. Cutting the wood will weaken the stab and it may break in flight.

*EXPERT TIP*

**HOW TO CUT COVERING FROM Balsa**

Use a 25-watt soldering iron to cut the covering from the stab. The tip of the soldering iron doesn't have to be sharp, but a fine-tip does work best. Allow the iron to heat fully. Use a metal straightedge to guide the soldering iron at a rate that will just melt the covering and not burn into the wood. The hotter the soldering iron, the faster it must travel to melt a fine cut. Allow the heat to melt the covering. Do not apply much pressure or the wood may be damaged. Peel off the covering.

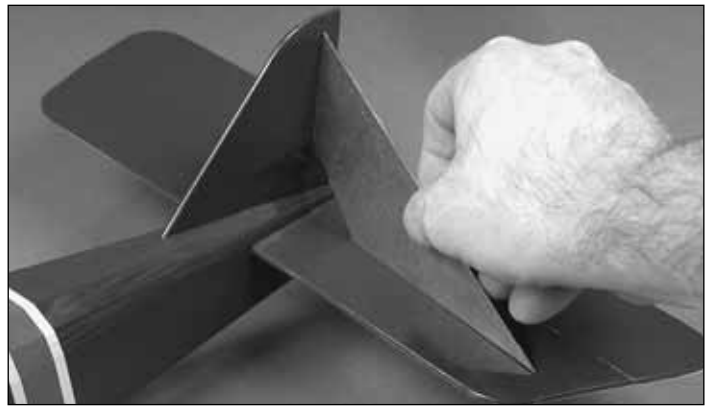

❑ 11. Test fit the fin in the fuselage. Make sure that the fin is perpendicular to the stabilizer and the TE is flush with the aft end of the fuselage.

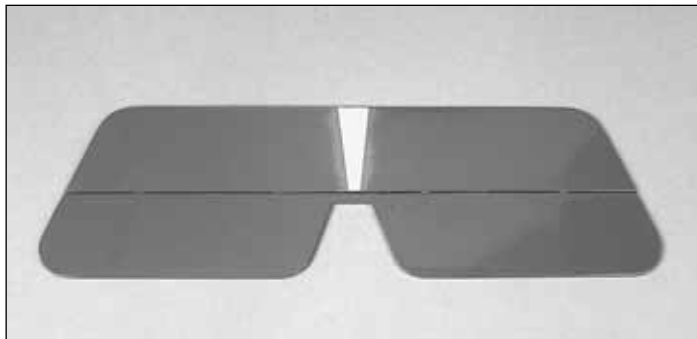

❑ 8. Temporarily attach the elevator to the stabilizer with four CA hinges. Make sure the stabilizer and elevator are aligned. If needed, use T-pins to hold the CA hinges centered in the elevator. Apply 3 drops of thin CA on the top and bottom of each hinge.

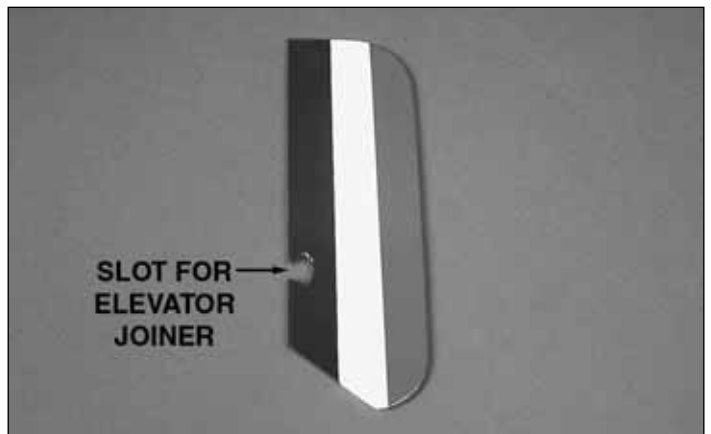

❑ 12. Trim the covering from over the slot in the LE of the rudder.

❑ 9. Reinstall the stabilizer in the fuselage. Use the string method to align the stabilizer. Then, glue the stabilizer to the fuselage with thin CA.



❑ 13. Install three CA hinges in the rudder and test fit it on the fin. Adjust the position of the fin so that the bottom of the rudder is even with the bottom of the fuselage and the LE of the rudder and the TE of the fin are aligned.

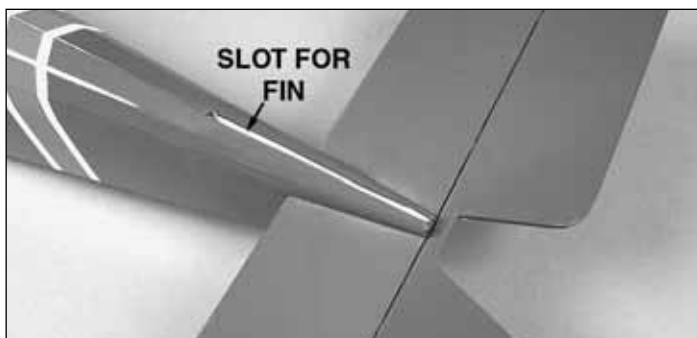

❑ 10. Cut the covering from over the slot in the fuselage for the fin.

❑ 14. Use a fine-point felt-tip pen to mark the outline of the fuselage onto each side of the fin.

## RADIO INSTALLATION

### Install the Motor & ESC

**Note:** You will need to have your motor battery charged later in this section. We recommend that you start charging it now so you do not have to wait for it to charge later. Make sure to closely follow the charging instructions for charging LiPo batteries.

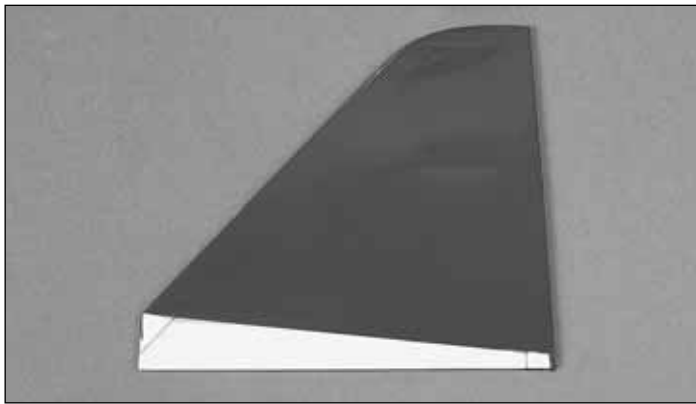

❑ 15. Remove the fin from the fuselage. Use a sharp #11 hobby knife or the *“Expert Tip”* on page 8 to cut the covering from the fin just inside the lines you marked. Use care to cut **only the covering** and not the wood. Cutting the wood will weaken the fin and it may break in flight.

❑ 16. Reinstall the fin and rudder. Check that everything is aligned. Then, use thin CA to glue the fin in the fuselage. Also use thin CA to glue the three CA hinges, centered in the fin and rudder.

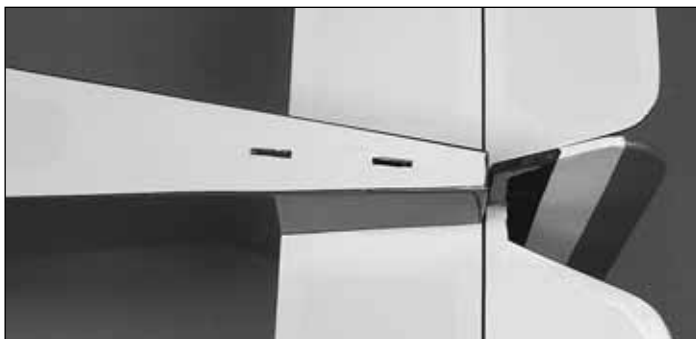

❑ 17. Cut the covering from over the two tail skid mounting holes on the bottom of the fuselage.



❑ 18. Attach the tail skid to the bottom of the fuselage using thin CA.

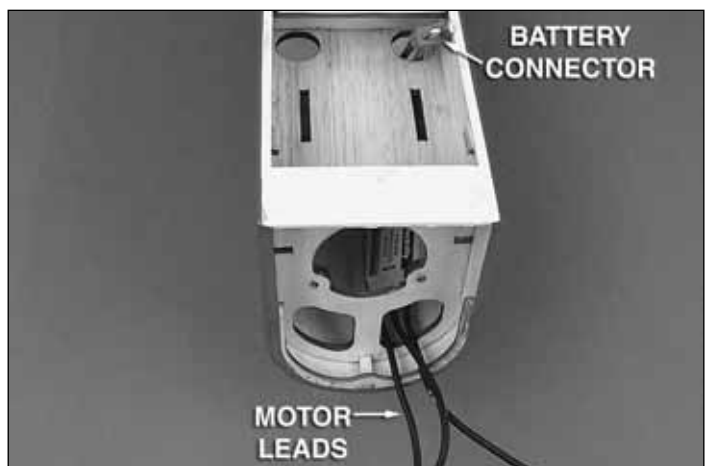
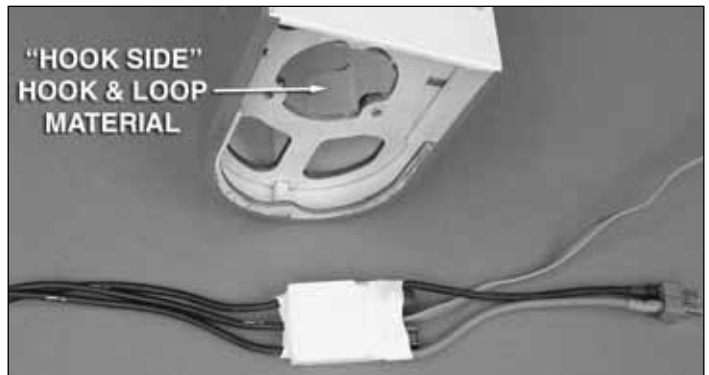

❑ 1. Cut a 20mm long piece of hook and loop material. Glue the 20mm soft piece (hook side) to the back of the ESC. Glue the rough piece (loop side) to the top of the inside of the fuselage. Insert the ESC through the front of the firewall. Route the battery connector out of one of the two holes at the back of the battery compartment. Route the servo lead into the wing opening and the three motor leads out the front of the firewall. The reason the ESC needs to be mounted in this location is so that it has a good flow of air over it.

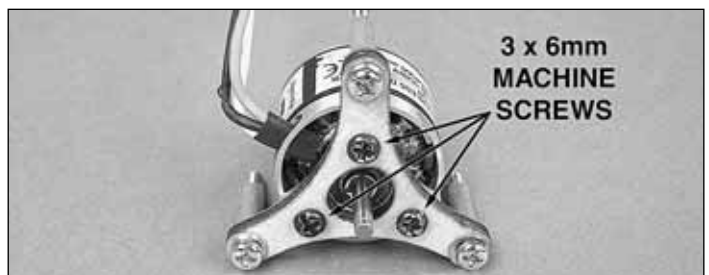

❑ 2. Attach the RimFire motor to the back of the plywood motor mount with three 3 x 6mm machine screws. Apply a drop of threadlocker on the threads of the machine screws.

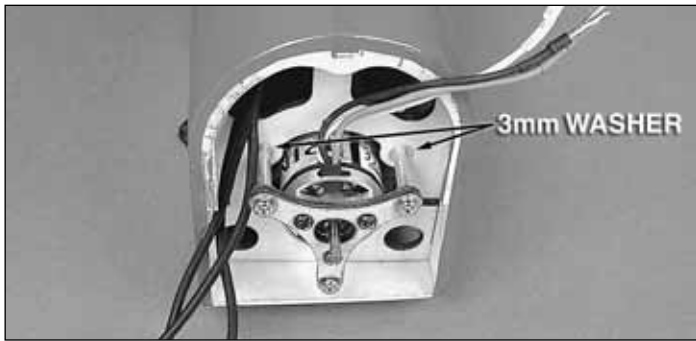

❑ 3. Place a 3mm washer over each of the three 3 x 26mm motor mount machine screws. Apply a drop of Threadlocker on the threads of each screw and install the motor mount to the firewall.



❑ 4. Install a 3.5mm Bullet (male) to 2mm Bullet (female) connector adapter (GPMM3122) on each of the motor leads. Connect the motor leads to the ESC. Then, stuff the wires into the fuselage to prevent them from contacting the rotating motor case.

### *Install the Control Horns*



❑ 1. Insert the two 460mm wire pushrods into the outer pushrod tubes inside the fuselage. Notice at the aft end of

the fuselage where the pushrods press against the covering. Using a sharp hobby knife, cut a small slot in the covering to allow the pushrod to exit the fuselage.

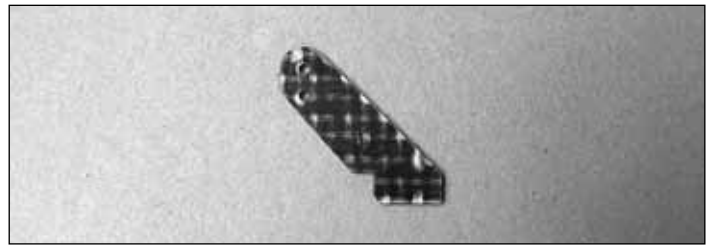
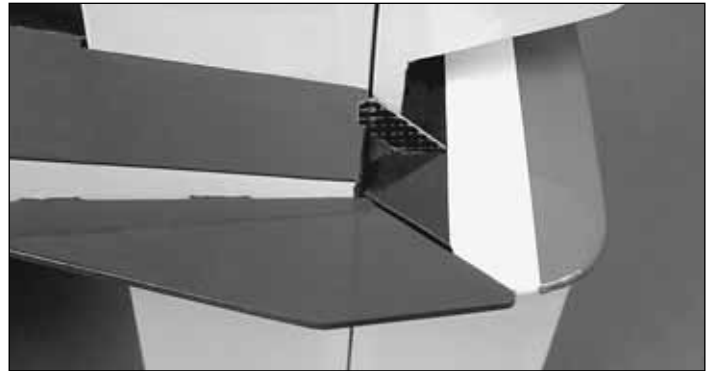

❑ 2. Use a sharp hobby knife to trim the covering from over the small rectangular hole towards the LE of the rudder. Do not cut all the way through the rudder. Test fit a control horn in the hole.



❑ 3. Insert the Z-bend of the 460mm pushrod into the outer hole of the control horn.

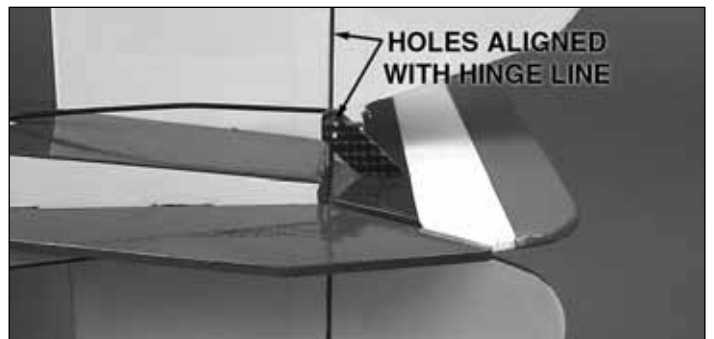

❑ 4. Insert the pushrod in the pushrod hole on the left side of the fuselage. Insert the control horn in the rudder and position it so that the pushrod holes are aligned with the rudder hinge line. Use CA to secure the control horn to the rudder.

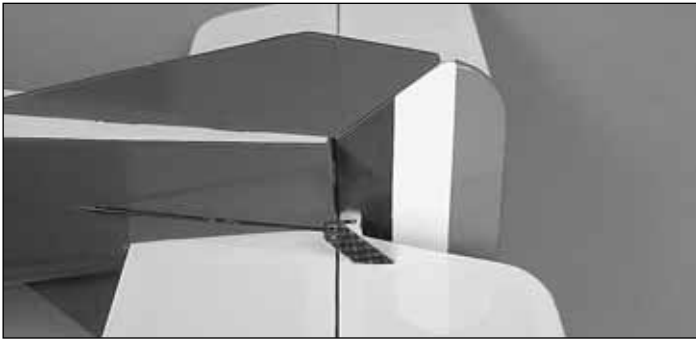

❑ 5. Install the elevator control horn following the same procedure.

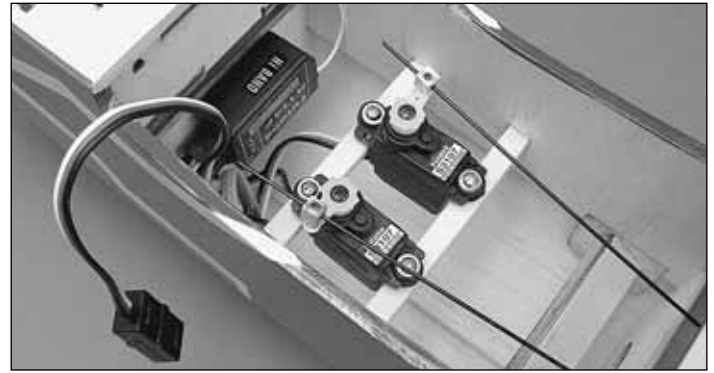

❑ 4. Plug a Y-harness into the aileron socket of the receiver. Attach the double-sided tape to the back of the receiver and mount the receiver to the back of the front radio compartment former. Be careful to not cover the two cooling holes in the former.

❑ 5. Follow the same procedure to connect the rudder pushrod.

### Install the Servos

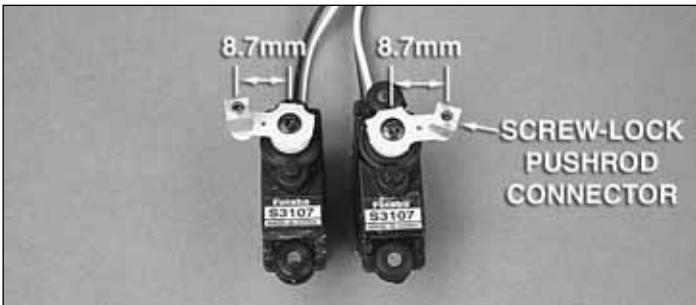

❑ 1. Install the grommets and servo arms on the rudder and elevator servos. Trim off the unused servo arms. Insert a screw-lock pushrod connector in the hole of each servo arm 8.7mm from the center of the servo. Secure the screw-lock pushrod connector to the servo arm with a nylon retainer.



❑ 6. Trim the covering from over the pushrod exit on the aileron servo hatch.

❑ 7. Plug one of the aileron servos into the aileron Y-harness. Switch on the transmitter and ESC and center the aileron trim and the servo. Trim the unused arms from the servo arm.

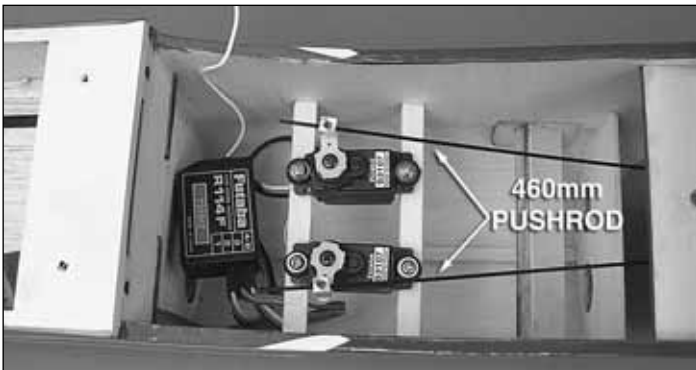

❑ 2. Plug the ESC, rudder and elevator servos into the receiver. Switch on the transmitter and then the ESC. Center the trims on the transmitter. Then, center the servo arms on the servos so that the arm is perpendicular to the centerline of the servo. Insert the rudder and elevator pushrod wires in screw-lock pushrod connectors and install the rudder and elevator servos on the servo rails. Use the hardware included with the servos to mount the servos to the rails.

❑ 3. Switch on the transmitter and the ESC. Center the elevator servo trim and the elevator. Tighten the set screw, in the screw-lock pushrod connector, against the elevator pushrod.



❑ 8. Clean the servo case with denatured alcohol. Use CA to glue the aileron servo on the bottom of the aileron servo hatch so that the servo arm is centered in the opening. If you prefer, wrap electrical tape or heat-shrink tubing around the servo before gluing it to the servo hatch. This will allow the servo to be easily removed.

□ □ 9. Connect a 305mm servo extension to the aileron servo. Use heat-shrink tubing or electrical tape around the connection to prevent it from coming loose. Tie the string that is located in the aileron servo bay to the end of the extension and pull the wire through the wing and out the center.

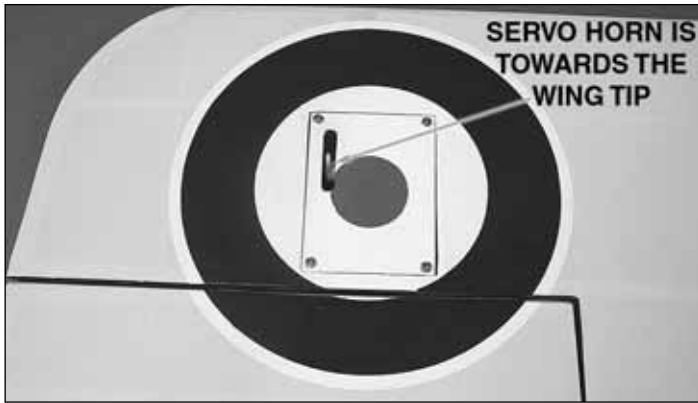

□ □ 10. Secure the aileron servo hatch to the wing with four 2 x 7mm self-tapping screws.



□ □ 11. Trim the covering from over the control horn slot. Insert a control horn and glue it with thin CA.

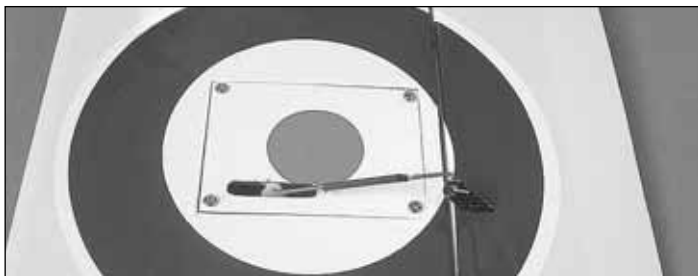

□ □ 12. Install a 35mm aileron pushrod in the outer hole of aileron servo arm and the outer hole of the aileron control horn. Slide a 25mm piece of heat-shrink tubing over the pushrods. With the radio system on and the aileron centered, shrink the heat-shrink tubing over the pushrods and apply a couple of drops of thin CA to the joint. **Note:** A heat gun or the shaft of a hot soldering iron works great for shrinking the heat-shrink tubing.

□ 13. Follow the same procedure to install the other aileron servo.

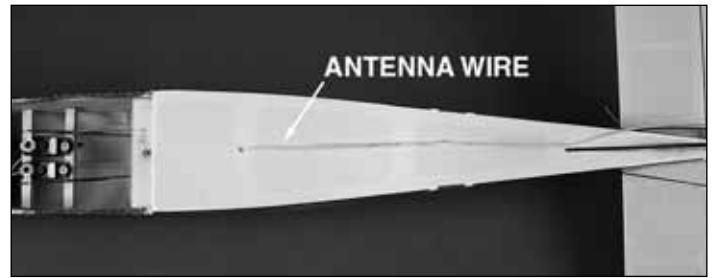

□ 14. Make a small hole in the bottom sheeting. Route the antenna out of the hole and tape it to the bottom of the fuselage.

### *Install the Top Wing*

**Note:** Dry fit the strut mounts to make sure they are in the correct location.

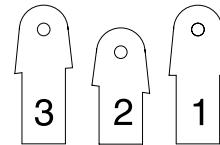

□ 1. On the top of the bottom wing, trim the covering from over the four strut mount pockets. Note that there are eight plywood strut mounts. Four are labeled #1, two are labeled #2 and two are labeled #3. Insert the #3's in the forward pockets of the bottom wing and the #2's in the aft pockets of the bottom wing. Also note that the lips on the mounts are angled to match the wing ribs.

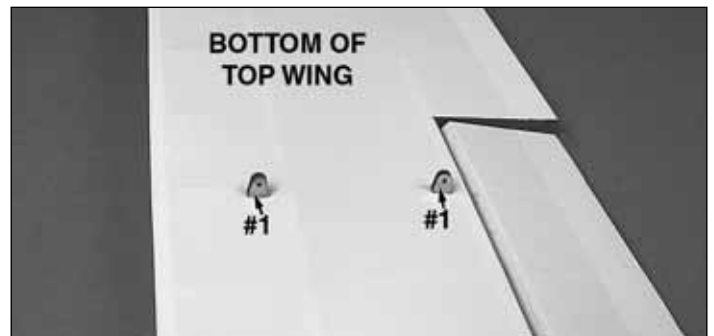

□ 2. Install the four #1 strut mounts in the bottom of the top wing following the same procedure.

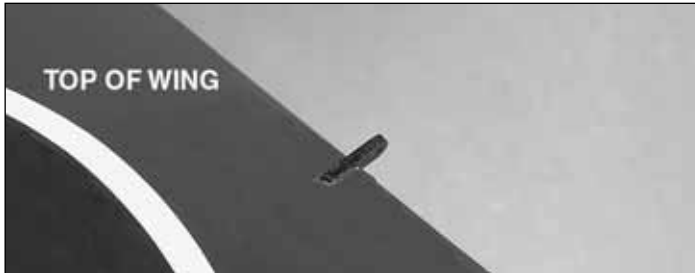
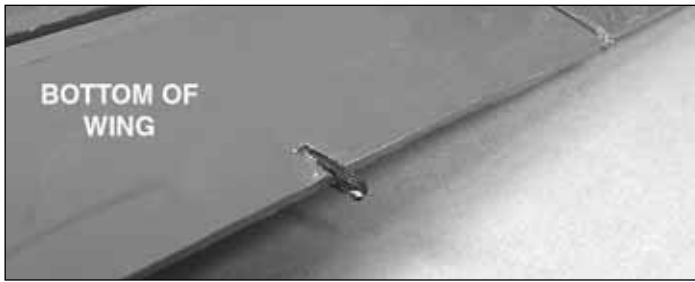

❑ 3. Trim the covering from over the four slots at the aft edge of the ailerons on the top and bottom wing. Insert a straight control horn in each slot. The control horn should be centered on the TE of the aileron. Secure the control horns with thin CA.

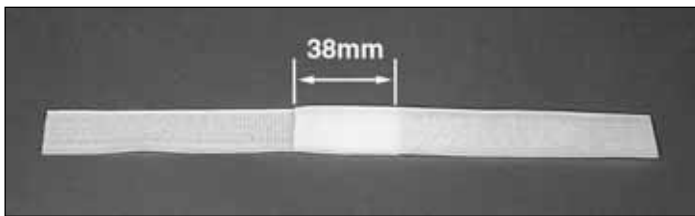

❑ 4. Take the two pieces of hook and loop material and overlap them by 38mm.

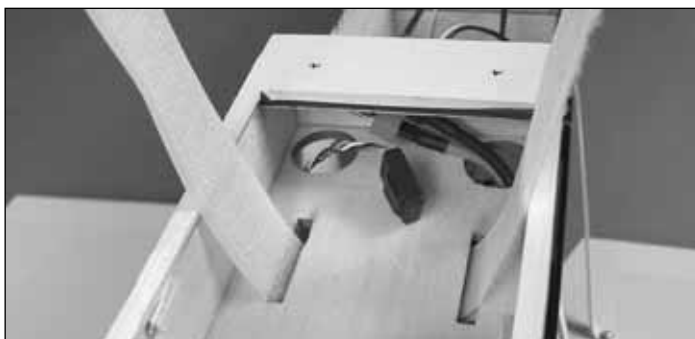

❑ 5. Route the hook and loop material through one of the slots in the battery compartment and back out the other slot.

❑ 6. Bolt the bottom wing back on the fuselage. Make sure the ailerons servos are plugged into the receiver.

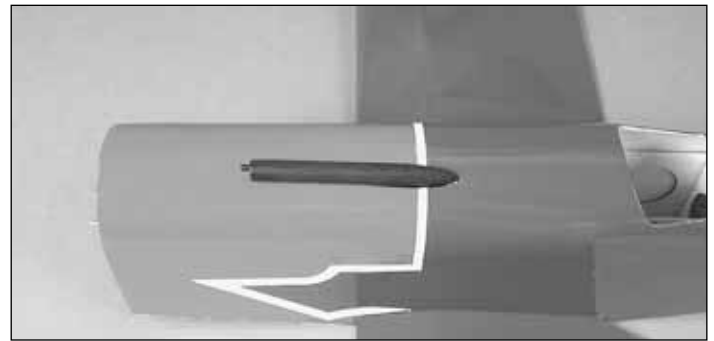

❑ 7. Use CA to glue the machine gun to the top of the fuselage.

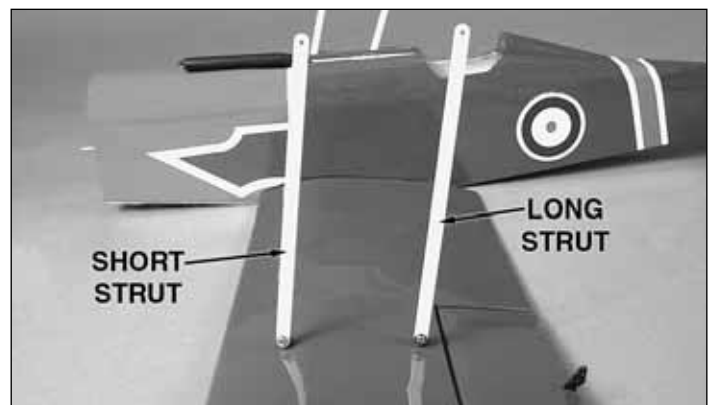

❑ 8. The S.E.5a EP ARF comes with two long and two short outer wing struts. Attach the short struts to the forward strut mounts of the bottom wing using 2 x 8mm self-tapping washer head screws. Attach the long struts to the aft strut mounts. Do not tighten the wing struts completely.



❑ 9. Trim the covering from over the openings for the cabanes, on both sides of the fuselage.

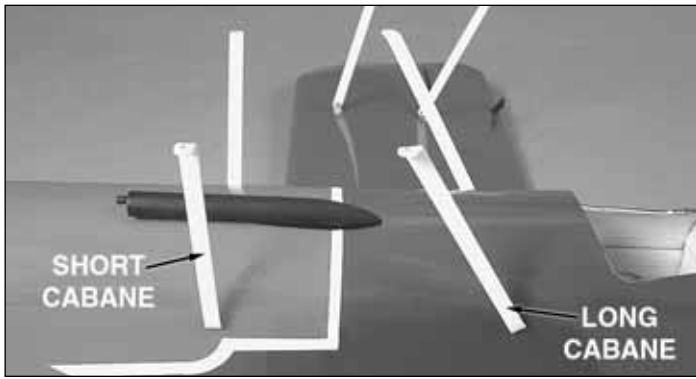

❑ 10. Insert the two short cabanes in the forward slots and the long cabanes in the aft slots as shown.

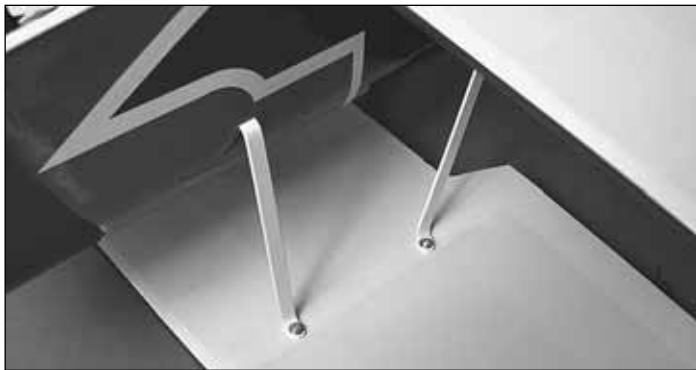

❑ 11. Attach the top wing to the cabanes and the outer wing struts with eight 2 x 8mm self-tapping washer head screws. Once you have determined that the strut mounts are in the correct location, use thin CA to glue them in the wing.

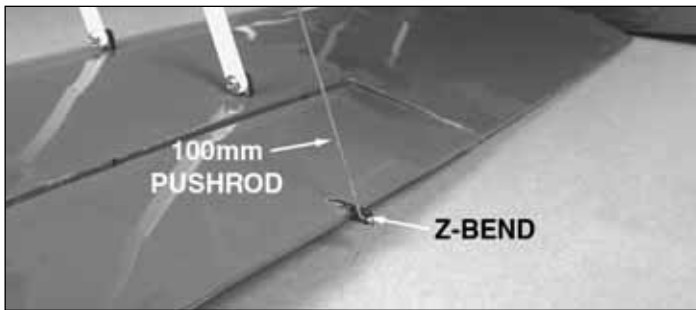

❑ 12. Install a 100mm pushrod with the Z-bend at one end in the control horn of the bottom wing aileron.

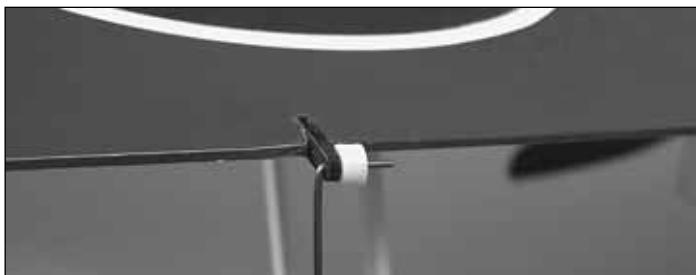

❑ 13. Install the 100mm pushrod with the L-bend in the control horn of the top wing's aileron. Secure it with a white plastic retainer.

❑ 14. Switch the radio system on. Make sure the ailerons are centered. Tape the top wing aileron in the neutral position.

❑ 15. Slide a 2.5 x 25mm piece of heat-shrink tubing over both pushrods with both the top and bottom ailerons centered. Shrink the heat-shrink tubing over the pushrods with a soldering iron and apply a couple of drops of thin CA to the joint.

❑ 16. Install the second set of pushrods between the other set of ailerons.

## FINISH THE MODEL

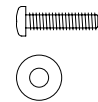

❑ 1. Attach the main landing gear using two 2 x 9mm machine screws and two 2mm flat washers. The landing gear should be positioned so that it is leaning forward. Do not fully tighten the screws.



❑ 2. Attach the landing gear supports to the main landing gear using two 2 x 5mm flat head screws. Do not tighten the screws.



□ 3. Attach the other end of the landing gear supports to the bottom of the wing with two 2 x 8mm washer head self-tapping screws. Once all the screws are installed they can be tightened.

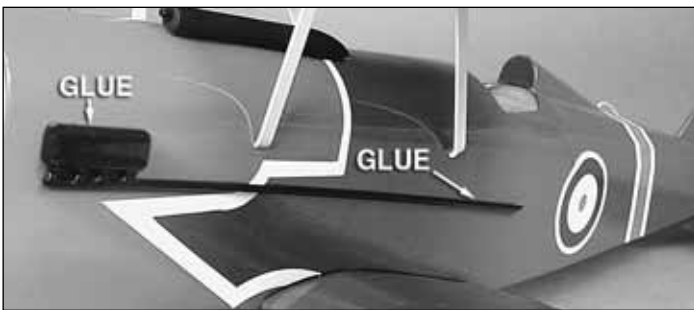

□ 4. Glue the exhaust to the side of the fuselage.



□ 5. Slide the prop shaft and collet onto the output shaft of the gear-drive. The collet has a tapered hole through it. The side with the larger hole goes on first. Use clear tape to attach the radiator to the front of the fuselage so that the prop adapter is centered in the opening of the radiator.

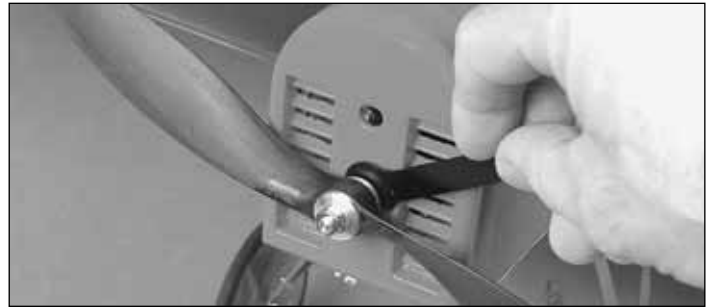

□ 6. Remove the prop nut and washer and install the 10x4.5 propeller. Reinstall the washer and prop nut and tighten the nut securely.



□ 7. Insert the battery in the battery compartment and secure it with the hook and loop material. Trim the excess hook and loop material.



□ 8. Slide the battery hatch into position. Note that the lip slides under the front of the fuselage and the aft end is held on with two magnets.

## GET THE MODEL READY TO FLY

### Check the Control Directions

**Warning:** Once the motor battery is connected to the ESC, stay clear of the propeller.

1. Switch on the transmitter and connect the motor battery to the ESC. Move the throttle stick down to the off position. Switch on the ESC and center the trims.

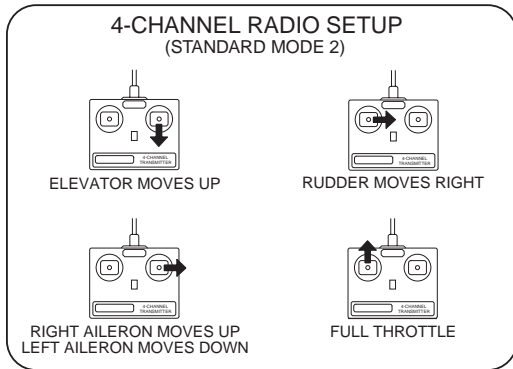

2. Make certain that the control surfaces respond in the correct direction as shown in the diagram. If any of the controls respond in the wrong direction, use the servo reversing in the transmitter to reverse the servos connected to those controls. Be certain the control surfaces have remained centered. Adjust if necessary.

3. Follow the instructions included with your ESC to arm the motor. Make sure the propeller is turning in the correct direction. If not, refer to the ESC instructions to change the direction of rotation.

**Warning!** Once the battery is connected to the ESC, stay clear of the propeller even if the ESC has not been armed.

### Set the Control Throws

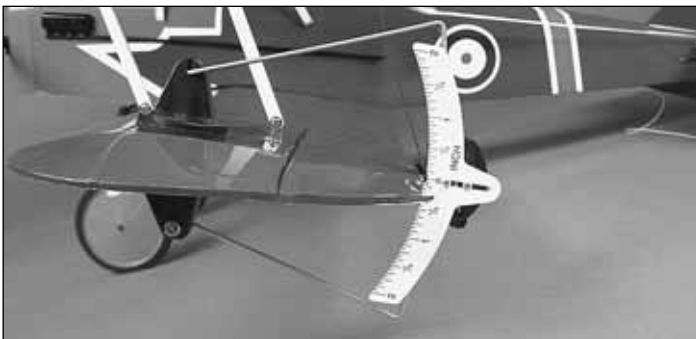

Use a Great Planes AccuThrow (or a ruler) to accurately measure and set the control throw of each control surface as indicated in the chart that follows. If your radio does not have dual rates, we recommend setting the throws at the **low rate** setting.

**Note:** The throws are measured at the **widest part** of the elevators, rudder and ailerons.

These are the recommended control surface throws:

	High Rate	Low Rate
<b>ELEVATOR:</b>	5/8" [16mm] up 5/8" [16mm] down	3/8" [9.5mm] up 3/8" [9.5mm] down
<b>RUDDER:</b>	1/2" [13mm] right 1/2" [13mm] left	3/8" [9.5mm] right 3/8" [9.5mm] left
<b>AILERONS:</b>	5/8" [16mm] up 5/8" [16mm] down	3/8" [9.5mm] up 3/8" [9.5mm] down

**IMPORTANT:** The S.E.5a EP ARF has been **extensively** flown and tested to arrive at the throws at which it flies best. Flying your model at these throws will provide you with the greatest chance for successful first flights. If, after you have become accustomed to the way the S.E.5a EP ARF flies, you would like to change the throws to suit your taste, that is fine. However, too much control throw could make the model difficult to control, so remember, "more is not always better."

### Balance the Model (C.G.)

More than any other factor, the **C.G.** (balance point) can have the **greatest** effect on how a model flies, and may determine whether or not your first flight will be successful. If you value this model and wish to enjoy it for many flights, **DO NOT OVERLOOK THIS IMPORTANT PROCEDURE.** A model that is not properly balanced will be unstable and possibly unflyable.

At this stage the model should be in ready-to-fly condition with all of the systems in place including the motor, landing gear, motor battery, and the radio system.

1. Use a felt-tip pen or 3mm-wide tape to accurately mark the C.G. on the bottom of the top wing on both sides of the fuselage. The C.G. is located 2-1/2" [64mm] back from the LE of the top wing.

This is where your model should balance for the first flights. Later, you may wish to experiment by shifting the C.G. up to 1/4" [6.4mm] forward or 1/4" [6.4mm] back to change the flying characteristics. Moving the C.G. forward may improve the smoothness and stability, but the model may then require more speed for takeoff and make it more difficult to slow for landing. Moving the C.G. aft makes the model more maneuverable, but could also cause it to become too difficult to control. In any case, **start at the recommended balance point** and do not at any time balance the model outside the specified range.

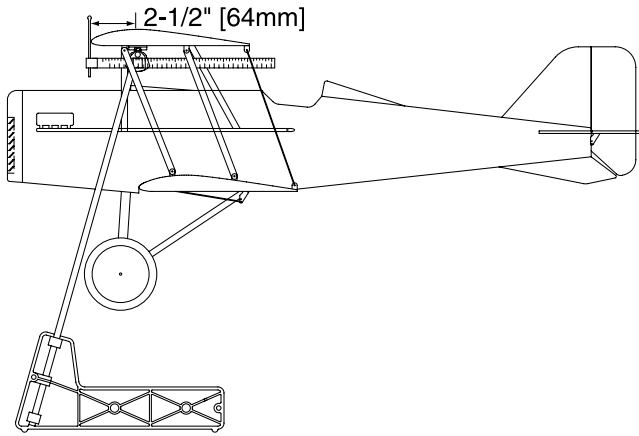

❑ 2. With the wing attached to the fuselage, all parts of the model installed (ready to fly) and the motor battery installed, place the model right-side up on a Great Planes CG Machine, or lift it at the balance point you marked.

❑ 3. If the tail drops, the model is “tail heavy” and the motor battery and/or receiver must be shifted forward or weight must be added to the nose to balance. If the nose drops, the model is “nose heavy” and the motor battery and/or receiver must be shifted aft or weight must be added to the tail to balance. If possible, move the motor battery and receiver forward or aft to minimize or eliminate any additional ballast required. If additional weight is required, use Great Planes “stick-on” lead (GPMQ4485). A good place to add stick-on nose weight is to the firewall (don’t attach weight to the cowl—it is not intended to support weight). Begin by placing incrementally increasing amounts of weight on the bottom of the fuse over the firewall until the model balances. Once you have determined the amount of weight required, it can be permanently attached. If required, tail weight may be added by cutting open the bottom of the fuse and gluing it permanently inside.

If moving the motor battery forward or aft will balance the plane without adding additional weight, mark the battery tray or the fuselage inside where the forward end of the battery should be placed. This will allow you to position the battery correctly before each flight.

❑ 4. **IMPORTANT:** If you found it necessary to add any weight, recheck the C.G. after the weight has been installed.

### ***Balance the Model Laterally***

❑ 1. With the wing level, lift the model by the prop shaft and the bottom of the fuse under the TE of the fin. Do this several times.

❑ 2. If one wing always drops when you lift the model, it means that side is heavy. Balance the airplane by adding weight to the other wing tip. **An airplane that has been laterally balanced will track better in loops and other maneuvers.**

## ***PREFLIGHT***

### ***Identify Your Model***

No matter if you fly at an AMA sanctioned R/C club site or if you fly somewhere on your own, you should always have your name, address, telephone number and AMA number on or inside your model. It is **required** at all AMA R/C club flying sites and AMA sanctioned flying events. Fill out the identification tag on the back cover page and place it on or inside your model.

### ***Charge the Transmitter Batteries***

Follow the battery charging instructions that came with your radio control system to charge the transmitter. You should always charge your transmitter the night before you go flying, and at other times as recommended by the radio manufacturer.

**CAUTION:** Unless the instructions that came with your radio system state differently, the **initial** charge on **new** transmitter batteries should be done for 15 hours **using the slow-charger that came with the radio system.** This will “condition” the batteries so that the next charge may be done using the fast-charger of your choice. If the initial charge is done with a fast-charger, the batteries may not reach their full capacity and you may be flying with batteries that are only partially charged.

### ***Balance the Propellers***

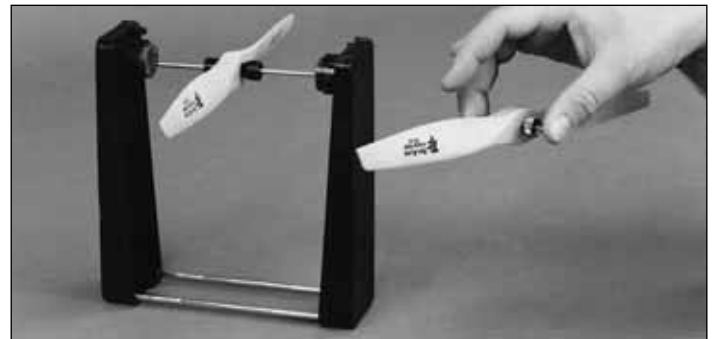

Carefully balance your propeller and spare propellers before you fly. An unbalanced prop can be the single most significant cause of vibration that can damage your model. Not only will motor mounting screws and bolts loosen, possibly with disastrous effect, but vibration may also damage your radio receiver and servos.

We use a Top Flite Precision Magnetic Prop Balancer™ (TOPQ5700) in the workshop and keep a Great Planes Fingertip Prop Balancer (GPMQ5000) in our flight box.

## Proper Care of Your Motor

Using multiple battery packs to run the motor for successive flights may cause the motor to become excessively hot. We recommend at least a 10-minute motor cool-down period between flights.

## Ground Check

After you break-in the motor on the model, inspect the model closely to make sure all screws remained tight, the hinges are secure, the prop is secure and all pushrods and connectors are secure.

## Range Check

Ground check the operational range of your radio before the first flight of the day. With the transmitter antenna collapsed and the receiver and transmitter on, you should be able to walk at least 100 feet [30m] away from the model and still have control. Have an assistant stand by your model and, while you work the controls, tell you what the control surfaces are doing. Repeat this test **with the motor running** at various speeds with an assistant holding the model, using hand signals to show you what is happening. If the control surfaces do not respond correctly, **do not fly!** Find and correct the problem first. Look for loose servo connections or broken wires, corroded wires on old servo connectors, poor solder joints in your battery pack or a defective cell, or a damaged receiver crystal from a previous crash.

## MOTOR & BATTERY SAFETY PRECAUTIONS

**Failure to follow these safety precautions may result in severe injury to yourself and others.**

Use safety glasses when running the motor.

Do not run the motor in an area of loose gravel or sand; the propeller may throw such material in your face or eyes.

Keep your face and body as well as all spectators away from the plane of rotation of the propeller as you run the motor.

Keep these items away from the prop: loose clothing, shirt sleeves, ties, scarfs, long hair or loose objects such as pencils or screwdrivers that may fall out of shirt or jacket pockets into the prop.

Always remove the LiPo battery from the plane before charging.

Always use a charger designed to charge LiPo batteries for charging the LiPo flight battery.

Never leave the LiPo battery unattended while charging. If the battery becomes more than just warm, discontinue charging.

## AMA SAFETY CODE (excerpts)

Read and abide by the following excerpts from the Academy of Model Aeronautics Safety Code. For the complete Safety Code refer to *Model Aviation* magazine, the AMA web site or the Code that came with your AMA license.

### General

- 1) I will not fly my model aircraft in sanctioned events, air shows, or model flying demonstrations until it has been proven to be airworthy by having been previously, successfully flight tested.
- 2) I will not fly my model aircraft higher than approximately 400 feet within 3 miles of an airport without notifying the airport operator. I will give right-of-way and avoid flying in the proximity of full-scale aircraft. Where necessary, an observer shall be utilized to supervise flying to avoid having models fly in the proximity of full-scale aircraft.
- 3) Where established, I will abide by the safety rules for the flying site I use, and I will not willfully and deliberately fly my models in a careless, reckless and/or dangerous manner.
- 5) I will not fly my model unless it is identified with my name and address or AMA number, on or in the model. **Note:** This does not apply to models while being flown indoors.
- 7) I will not operate models with pyrotechnics (any device that explodes, burns, or propels a projectile of any kind).

### Radio Control

- 1) I will have completed a successful radio equipment ground check before the first flight of a new or repaired model.
- 2) I will not fly my model aircraft in the presence of spectators until I become a qualified flier, unless assisted by an experienced helper.
- 3) At all flying sites a straight or curved line(s) must be established in front of which all flying takes place with the other side for spectators. Only personnel involved with flying the aircraft are allowed at or in the front of the flight line. Intentional flying behind the flight line is prohibited.
- 4) I will operate my model using only radio control frequencies currently allowed by the Federal Communications Commission.
- 5) **I will not knowingly operate my model within three miles of any pre-existing flying site except in accordance with the frequency sharing agreement listed [in the complete AMA Safety Code].**
- 9) Under no circumstances may a pilot or other person touch a powered model in flight; **nor should any part of the model other than the landing gear, intentionally touch the ground, except while landing.**

## CHECK LIST

During the last few moments of preparation your mind may be elsewhere anticipating the excitement of the first flight. Because of this, you may be more likely to overlook certain checks and procedures that should be performed before the model is flown. To help avoid this, a check list is provided to make sure these important areas are not overlooked. Many are covered in the instruction manual, so where appropriate, refer to the manual for complete instructions. Be sure to check the items off as they are completed.

1. Check the C.G. according to the measurements provided in the manual.
2. Be certain the motor battery and receiver are securely mounted in the fuse.
3. Extend your receiver antenna and make sure it has a strain relief inside the fuselage to keep tension off the solder joint inside the receiver.
4. Balance your model *laterally* as explained in the instructions.
5. Make sure all hinges are **securely** glued in place.
6. Reinforce holes for wood screws with thin CA where appropriate (servo mounting screws, cabane mounting screws, etc.).
7. Confirm that all controls operate in the correct direction and the throws are set up according to the manual.
8. Make sure that all servo arms are secured to the servos with the screws included with your radio.
9. Secure connections between servo wires and Y-connectors or servo extensions with vinyl tape, heat-shrink tubing or special clips suitable for that purpose.
10. Make sure any servo extension cords you may have used do not interfere with other systems (servo arms, pushrods, etc.).
11. Balance your propeller (and spare propellers).
12. Tighten the propeller nut.
13. Place your name, address, AMA number and telephone number on or inside your model.
14. If you wish to photograph your model, do so before your first flight.
15. Range check your radio when you get to the flying field.

## FLYING

The S.E.5a EP ARF is a great-flying model that flies smoothly and predictably. The S.E.5a EP ARF does not, however, possess the self-recovery characteristics of a primary R/C trainer and should be flown only by experienced R/C pilots.

**CAUTION (THIS APPLIES TO ALL R/C AIRPLANES):** If, while flying, you notice an alarming or unusual sound such as a low-pitched "buzz," this may indicate control surface *flutter*. Flutter occurs when a control surface (such as an aileron or elevator) or a flying surface (such as a wing or stab) rapidly vibrates up and down (thus causing the noise). In extreme cases, if not detected immediately, flutter can actually cause the control surface to detach or the flying surface to fail, thus causing loss of control followed by an impending crash. The best thing to do when flutter is detected is to slow the model **immediately** by reducing power, then land as soon as safely possible. Identify which surface fluttered (so the problem may be resolved) by checking all the servo grommets for deterioration or signs of vibration. Make certain all pushrod linkages are secure and free of play. If it fluttered once, under similar circumstances it will probably flutter again unless the problem is fixed. Some things which can cause flutter are; Excessive hinge gap; Not mounting control horns solidly; Poor fit of clevis pin in horn; Side-play of wire pushrods caused by large bends; Excessive free play in servo gears; Insecure servo mounting; and one of the most prevalent causes of flutter; Flying an over-powered model at excessive speeds.

## Takeoff

Before you get ready to takeoff, see how the model handles on the ground by doing a few practice runs at **low speeds** on the runway. If you need to calm your nerves before the maiden flight, shut the motor off and bring the model back into the pits. Top off the battery, and then check all fasteners and control linkages for peace of mind.

Remember to takeoff into the wind. When you're ready, point the model straight down the runway and gradually advance the throttle. As the model gains speed, allow the tail to come off the ground. One of the most important things to remember with a taildragger is to always be ready to apply **right** rudder to counteract motor torque. Gain as much speed as your runway and flying site will practically allow before gently applying up elevator, lifting the model into the air. At this moment it is likely that you will need to apply more right rudder to counteract motor torque. Be smooth on the elevator stick, allowing the model to establish a **gentle** climb to a safe altitude before turning into the traffic pattern.

## Flight

For reassurance and to keep an eye on other traffic, it is a good idea to have an assistant on the flight line with you. Tell him to remind you to throttle back once the plane gets to a comfortable altitude. While full throttle is usually desirable for takeoff, most models fly more smoothly at reduced speeds.

Take it easy with the S.E.5a EP ARF for the first few flights, gradually getting acquainted with it as you gain confidence. Adjust the trims to maintain straight and level flight. After flying around for a while, and while still at a safe altitude with plenty of battery power remaining, practice slow flight and execute practice landing approaches by reducing the throttle to see how the model handles at slower speeds. Add power to see how she climbs as well. Continue to fly around, executing various maneuvers and making mental notes (or having your assistant write them down) of what trim or C.G. changes may be required to fine tune the model so it flies the way you like. Mind your battery power but use this first flight to become familiar with your model before landing.

## Landing

To initiate a landing approach, lower the throttle while on the downwind leg. Allow the nose of the model to pitch downward to gradually bleed off altitude. Continue to lose altitude, but maintain airspeed by keeping the nose down as you turn onto the crosswind leg. Make your final turn toward the runway (into the wind) keeping the nose down to maintain airspeed and control. Level the attitude when the model reaches the runway

**ALSO AVAILABLE FROM  
GREAT PLANES**



### Futaba® 4EXA 4-Channel Computer Radio

The 4EXA stores up to 4 models in memory, and lets you call them up in seconds. Programming is easy; using just two keys and a lever. But the 4EXA's biggest benefit is this: room to grow. With the 4EXA, EPA for servos, expo, wing mixing for V-tail and elevon are at your fingertips whenever you want them. Includes an R124 receiver, full NiCds and three S3108M servos. 72 MHz. **FUTK41\*\***

threshold, modulating the throttle as necessary to maintain your glide path and airspeed. If you are going to overshoot, smoothly advance the throttle (always ready on the right rudder to counteract torque) and climb out to make another attempt. But, if your battery power is low, do not attempt to go around again. It is better to land long than risk stalling the plane by flying too slow because the motor battery is low on power. When you're ready to make your landing flare and the model is a foot or so off the deck, smoothly increase up elevator until it gently touches down.

One final note about flying your model. Have a goal or flight plan in mind for **every** flight. This can be learning a new maneuver(s), improving a maneuver(s) you already know, or learning how the model behaves in certain conditions (such as on high or low rates). This is not necessarily to improve your skills (*though it is never a bad idea!*), but more importantly so you do not surprise yourself by impulsively attempting a maneuver and suddenly finding that you've run out of time, altitude or airspeed. Every maneuver should be deliberate, not impulsive. For example, if you're going to do a loop, check your altitude, mind the wind direction (anticipating rudder corrections that will be required to maintain heading), remember to throttle back at the top, and make certain you are on the desired rates (high/low rates). A flight plan greatly reduces the chances of crashing your model just because of poor planning and impulsive moves. **Remember to think.**

***Have a ball! But always stay in control and fly in a safe manner.***

**GOOD LUCK AND GREAT FLYING!**

This model belongs to:

Name

Address

City, State Zip

Phone number

AMA number

***Make a copy of this identification tag and put it on or inside your model.***