

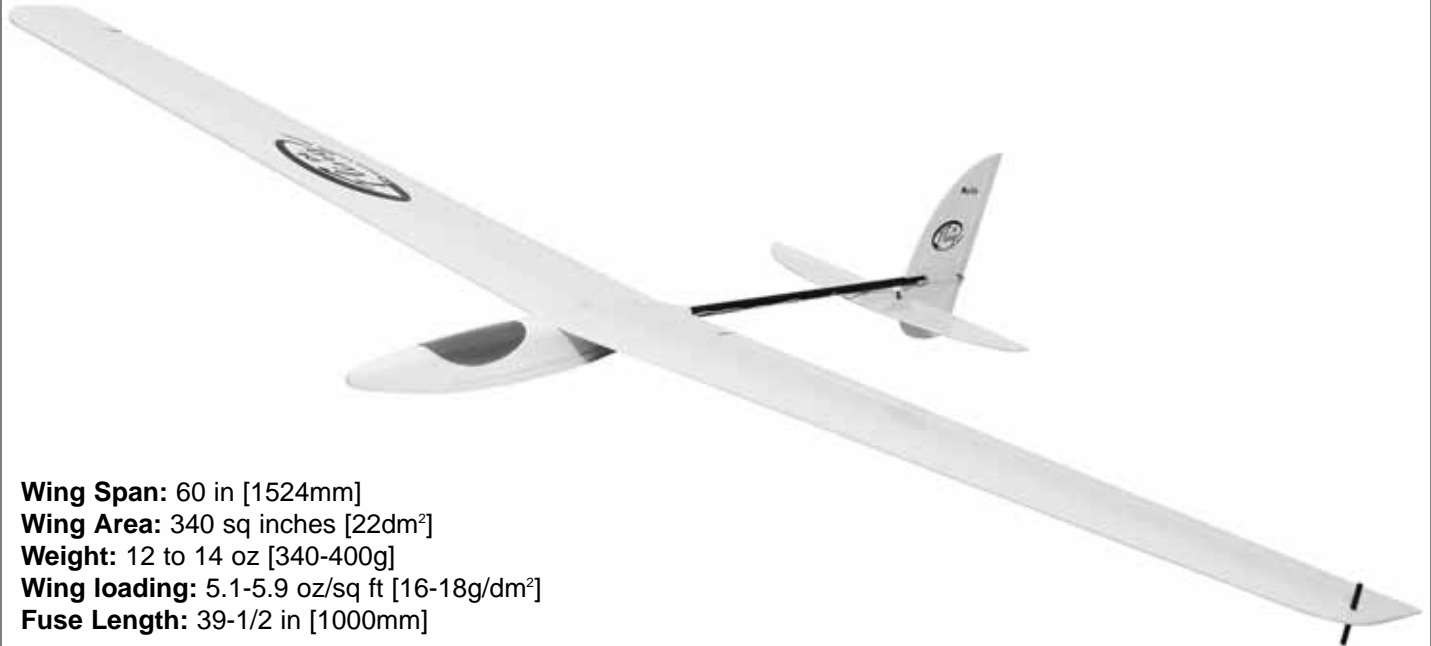

ARF

INSTRUCTION MANUAL



Wing Span: 60 in [1524mm]
Wing Area: 340 sq inches [22dm²]
Weight: 12 to 14 oz [340-400g]
Wing loading: 5.1-5.9 oz/sq ft [16-18g/dm²]
Fuse Length: 39-1/2 in [1000mm]

WARRANTY

Great Planes® Model Manufacturing Co. guarantees this kit to be free from defects in both material and workmanship at the date of purchase. This warranty does not cover any component parts damaged by use or modification. In no case shall Great Planes' liability exceed the original cost of the purchased kit. Further, Great Planes reserves the right to change or modify this warranty without notice.

In that Great Planes has no control over the final assembly or material used for final assembly, no liability shall be assumed nor accepted for any damage resulting from the use by the user of the final user-assembled product. By the act of using the user-assembled product, the user accepts all resulting liability.

If the buyer is not prepared to accept the liability associated with the use of this product, the buyer is advised to return this kit immediately in new and unused condition to the place of purchase.

To make a warranty claim send the defective part or item to Hobby Services at this address:

Hobby Services
3002 N. Apollo Dr., Suite 1
Champaign IL 61822
USA

Include a letter stating your name, return shipping address, as much contact information as possible (daytime telephone number, fax number, e-mail address), a detailed description of the problem and a photocopy of the purchase receipt. Upon receipt of the package the problem will be evaluated as quickly as possible.

READ THROUGH THIS MANUAL BEFORE STARTING CONSTRUCTION. IT CONTAINS IMPORTANT INSTRUCTIONS AND WARNINGS CONCERNING THE ASSEMBLY AND USE OF THIS MODEL.



Champaign, IL
(217) 398-8970, Ext. 5
airsupport@greatplanes.com

TABLE OF CONTENTS

INTRODUCTION	2
AMA	2
SAFETY PRECAUTIONS	3
DECISIONS YOU MUST MAKE	3
Radio Equipment.....	3
ADDITIONAL ITEMS REQUIRED	3
Adhesives & Building Supplies.....	3
IMPORTANT BUILDING NOTES.....	4
ORDERING REPLACEMENT PARTS	4
KIT CONTENTS.....	5
Parts Photographed	5
Parts Not Photographed.....	5
ASSEMBLE THE WING	6
Install the Aileron Servos	6
Join the Wing.....	7
ASSEMBLE THE FUSELAGE	7
Canopy Removal	7
Attach the Tail.....	8
Install Rudder and Elevator Servos.....	9
FINAL INSTALLATION AND C.G.....	11
Install the Throwing Peg.....	11
Set the CG	11
Apply the Decals	11
GET THE MODEL READY TO FLY	11
Check the Control Directions	11
Set the Control Throws.....	12
Balance the Model Laterally.....	12
PREFLIGHT	12
Identify Your Model	12
Charge the Batteries	12
Range Check.....	12
AMA SAFETY CODE	13
General.....	13
Radio Control	13
CHECK LIST	13
FLYING.....	14
Launching.....	14
THERMAL FLYING	15
Facts About Thermals	15
Thermal Soaring.....	15
Slope Soaring.....	16
Slope Landings	16

INTRODUCTION

The **Fling DL™ ARF** is a great way to have fun and try your hand at Discuss Launched flight. This style of launching is easy to learn and allows launches into thermals even if the thermal is right above you. The Fling DL has few parts enabling easy and quick assembly and will get you to the flying field fast. Items required for assembly are micro or nano servos, a micro receiver and a micro Rx battery pack. The specific recommended radio gear is listed in the “**Radio Equipment**” section of the manual. Have a friend get a Fling DL ARF too, and you can have “first up / last down” contests or compete against each other trying to land the Fling DL ARF closest to a certain place...a spot landing! Have fun with your new Fling DL ARF!

For the latest technical updates or manual corrections to the Fling DL ARF visit the Great Planes web site at www.greatplanes.com. Open the “Airplanes” link, then select the Fling DL ARF. If there is new technical information or changes to this model a “tech notice” box will appear in the upper left corner of the page.

AMA

We urge you to join the AMA (Academy of Model Aeronautics) and a local R/C club. The AMA is the governing body of model aviation and membership is required to fly at AMA clubs. Though joining the AMA provides many benefits, one of the primary reasons to join is liability protection. Coverage is not limited to flying at contests or on the club field. It even applies to flying at public demonstrations and air shows. Failure to comply with the Safety Code (excerpts printed in the back of the manual) may endanger insurance coverage. Additionally, training programs and instructors are available at AMA club sites to help you get started the right way. There are over 2,500 AMA chartered clubs across the country. Contact the AMA at the address or toll-free phone number below:



Academy of Model Aeronautics

5151 East Memorial Drive

Muncie, IN 47302

Tele: (800) 435-9262

Fax (765) 741-0057

Or via the Internet at:

<http://www.modelaircraft.org>

PROTECT YOUR MODEL, YOURSELF & OTHERS...FOLLOW THESE IMPORTANT SAFETY PRECAUTIONS

IMPORTANT!!! Two of the most important things you can do to preserve the radio-controlled aircraft hobby are to avoid flying near full-scale aircraft and avoid flying near or over groups of people.

1. Your Fling DL ARF should not be considered a toy, but rather a sophisticated, working model that functions very much like a full-size airplane. Because of its performance capabilities, the Fling DL ARF, if not assembled and operated correctly, could possibly cause injury to yourself or spectators and damage to property.

2. You must assemble the model **according to the instructions**. Do not alter or modify the model, as doing so may result in an unsafe or unflyable model. In a few cases the instructions may differ slightly from the photos. In those instances the written instructions should be considered as correct.

3. You must take time to **build straight, true and strong**.

4. You must correctly install all R/C and other components so that the model operates correctly on the ground and in the air.

5. You must check the operation of the model before **every** flight to insure that all equipment is operating and that the model has remained structurally sound. Be sure to check clevises or other connectors often and replace them if they show any signs of wear or fatigue.

6. If you are not an experienced pilot or have not flown this type of model before, we recommend that you get the assistance of an experienced pilot in your R/C club for your first flights. If you're not a member of a club, your local hobby shop has information about clubs in your area whose membership includes experienced pilots.

We, as the kit manufacturer, provide you with a top quality, thoroughly tested kit and instructions, but ultimately the quality and flyability of your finished model depends on how you build it; therefore, we cannot in any way guarantee the performance of your completed model, and no representations are expressed or implied as to the performance or safety of your completed model.

Remember: Take your time and follow the instructions to end up with a well-built model that is straight and true.

DECISIONS YOU MUST MAKE

This is a partial list of items required to finish the Fling DL ARF that may require planning or decision making before starting to build. Order numbers are provided in parentheses.

Radio Equipment

- 4 channel radio
- Y-harness (HCAM2500) or two 12" [300mm] extensions (HCAM2100) utilizing a radio with flaperon mixing
- Great Planes ElectriFly™ 4-channel mini receiver w/o crystal (GPML0044 for low band, GPML0045 for high band)
- Low band receiver crystal for Great Planes mini receivers (channels 11 to 35, FUTL62**)
- High band receiver crystal for Great Planes mini receivers (channels 36 to 60, FUTL63**)
- (4) Futaba® S3108 micro servos (FUTM0042)
- Great Planes 4.8V 350 mAh NiMH receiver battery (GPMP0950)

ADDITIONAL ITEMS REQUIRED

Adhesives & Building Supplies

In addition to common household tools and hobby tools, this is the "short list" of the most important items required to build the Fling DL ARF. **Great Planes Pro™** CA and Epoxy glue are recommended.

- 1/4" [6mm] R/C foam rubber – (HCAQ1000)
- 1/2 oz. [15g] Thin Pro CA (GPMR6001)
- Pro 30-minute epoxy (GPMR6047)
- Plan Protector (GPMR6167) or wax paper
- #1 Hobby knife (HCAR0105)
- #11 Blades (5-pack, HCAR0211)
- 2 oz. [57g] Spray CA activator (GPMR6035)
- Mixing cups (GPMR8056)
- Epoxy brushes (6, GPMR8060)
- Builder's Triangle Set (HCAR0480)

IMPORTANT BUILDING NOTES

- Whenever the term **glue** is written you should rely upon your experience to decide what type of glue to use. When a specific type of adhesive works best for that step, the instructions will make a recommendation.
- Whenever just **epoxy** is specified you may use **either** 30-minute (or 45-minute) epoxy **or** 6-minute epoxy. When 30-minute epoxy is specified it is **highly** recommended that you use only 30-minute (or 45-minute) epoxy, because you will need the working time and/or the additional strength.
- **Photos** and **sketches** are placed **before** the step they refer to. Frequently you can study photos in following steps to get another view of the same parts.

To convert inches to millimeters, multiply inches by 25.4 (25.4mm = 1")

ORDERING REPLACEMENT PARTS

Replacement parts for the Great Planes Fling DL ARF are available using the order numbers in the **Replacement Parts List** that follows. The fastest, most economical service can be provided by your hobby dealer or mail-order company.

To locate a hobby dealer, visit the Hobbico web site at www.hobbico.com. Choose "Where to Buy" at the bottom of the menu on the left side of the page. Follow the instructions provided on the page to locate a U.S., Canadian or International dealer. If a hobby shop is not available, replacement parts may also be ordered from Tower Hobbies at www.towerhobbies.com, or by calling toll free (800) 637-6050.

Parts may also be ordered directly from Hobby Services by calling (217) 398-0007, or via facsimile at (217) 398-7721, but full retail prices and shipping and handling charges will apply. Illinois and Nevada residents will also be charged sales tax. If ordering via fax, include a Visa® or MasterCard® number and expiration date for payment.

Mail parts orders and payments by personal check to:

Hobby Services
3002 N Apollo Drive, Suite 1
Champaign IL 61822

Be certain to specify the order number exactly as listed in the **Replacement Parts List**. Payment by credit card or personal check only; no C.O.D.

If additional assistance is required for any reason contact Product Support by e-mail at productsupport@greatplanes.com, or by telephone at (217) 398-8970.

Order Number	Description	How to purchase
GPMA2709.....	Wing Set.....	Contact your local hobby supplier
GPMA2708.....	Fuselage.....	Contact your local hobby supplier
GPMA2710.....	Tail Set.....	Contact your local hobby supplier
GPMA2711.....	Hardware Set	Contact your local hobby supplier
GPMA2712.....	Canopy	Contact your local hobby supplier
GPMA2713.....	Decal Set.....	Contact your local hobby supplier
	Missing pieces.....	Contact Product Support
	Instruction manual.....	Contact Product Support
	Full-size plans	Not available

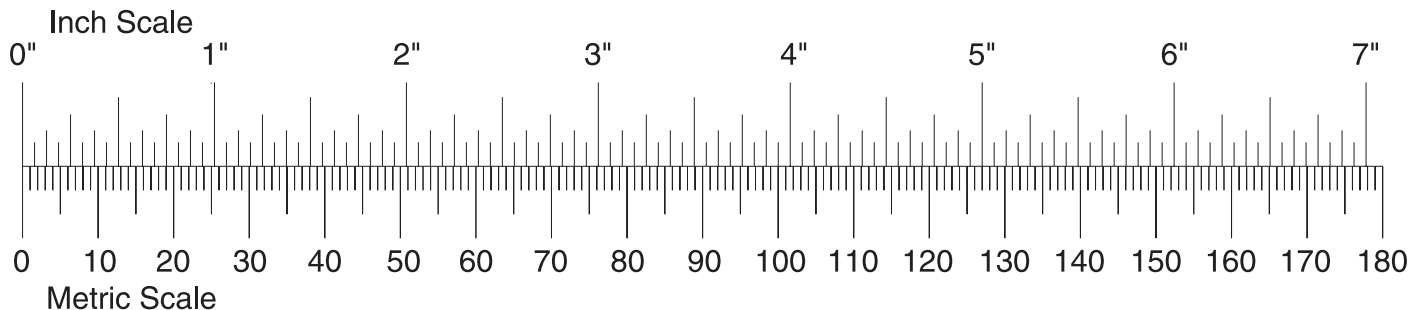

KIT CONTENTS

Before starting to build, take an inventory of this kit to make sure it is complete, and inspect the parts to make sure they are of acceptable quality. If any parts are missing or are not of acceptable quality, or if you need assistance with assembly, contact Product Support. When reporting defective or missing parts, use the part names exactly as they are written in the Kit Contents list.

Great Planes Product Support
3002 N Apollo Drive, Suite 1
Champaign, IL 61822
Telephone: (217) 398-8970, ext. 5
Fax: (217) 398-7721
E-mail: airsupport@greatplanes.com

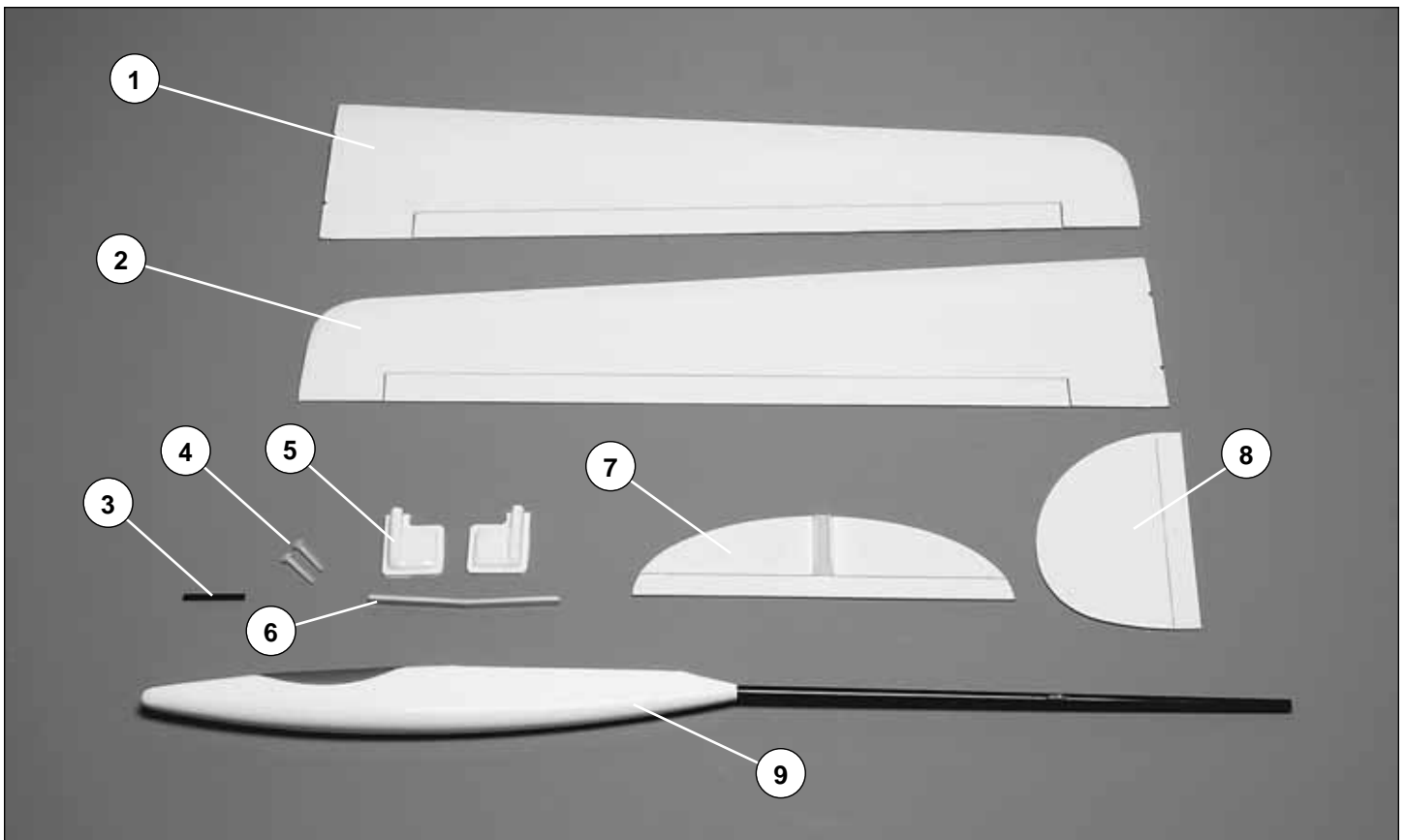

Kit Contents

Parts Photographed

1. Right wing and aileron
2. Left wing and aileron
3. Carbon throwing peg
4. 8-32 nylon wing bolts
5. Aileron servo hatches
6. Wing joiner
7. Horizontal stab and elevator
8. Vertical fin and rudder
9. Fuselage and canopy

Parts Not Photographed

1. Plywood aileron and elevator control horns (3)
2. Plywood rudder control horn
3. 6" [152mm] Aileron pushrods
4. Bag of steel shot
5. 39" [1meter] thin wire
6. Spool of pull/pull string
7. Plastic pull/pull elevator turnaround
8. Decal sheet

ASSEMBLE THE WING

Install the Aileron Servos

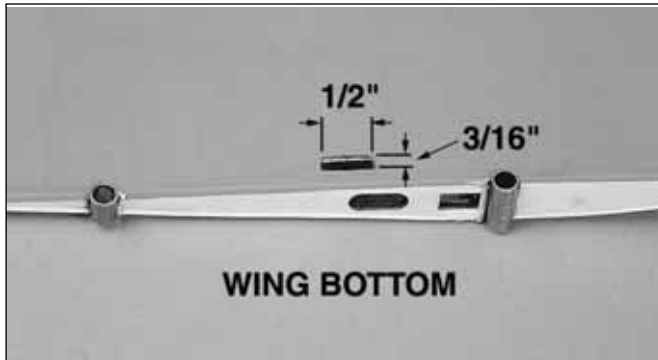

1. Cut a 3/16" x 1/2" [4.8 x 13mm] slot in the bottom of the wing centered with the aft end of the hole in the root rib and 3/16" [4.8mm] from the wing center.

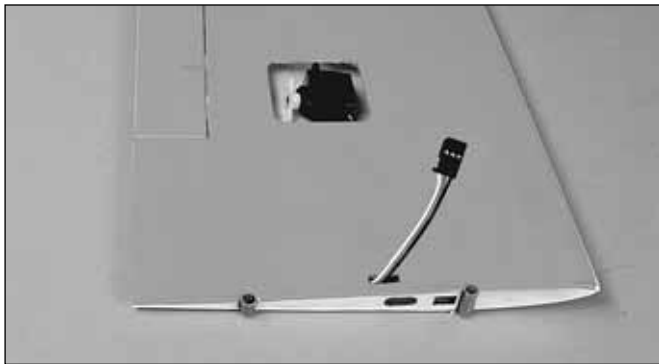

2. Slide the aileron servo lead through the wing and out the hole you just made.

3. Plug the servos and battery into your receiver. Turn on the transmitter to center the servos.

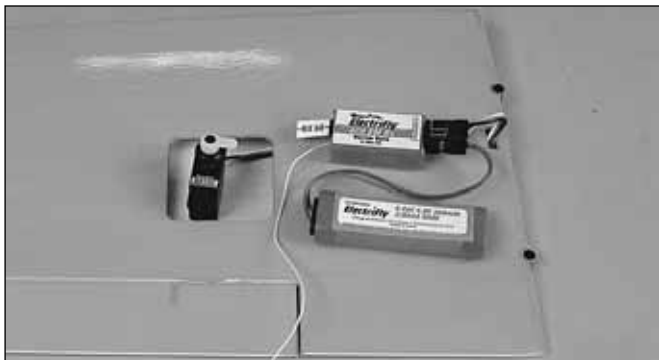

4. Make a one-sided servo arm and position it on the servo as shown in the picture. Make sure that the arm is centered with the radio on and the trim centered.

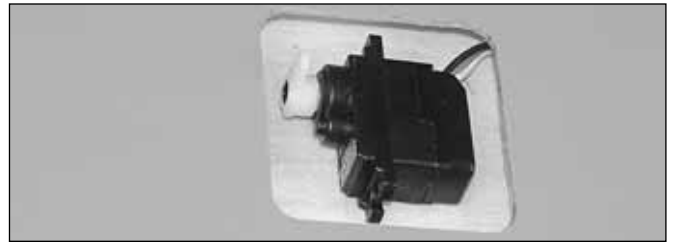

5. Clean the side of the servo with alcohol. Lightly coat the inside of the servo opening with medium CA. Press the servo into the center of the servo opening. Use the pushrod and servo cover to position the servo.

NOTE: If the CA is not spread thin enough it might wick into the servo and cause the gears to bind. **Do Not Use Thin CA!**

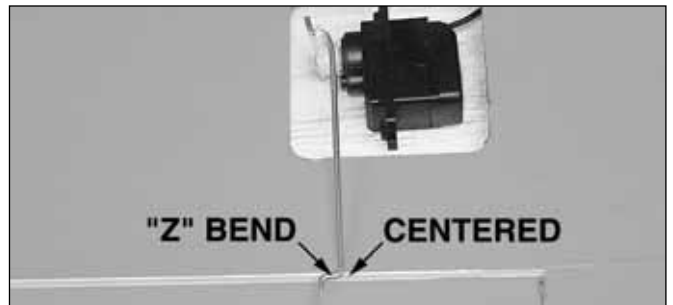

6. From the 1/16" x 6" [1.6mm x 150mm] pushrod make a pushrod with Z bends on each end that goes from the servo arm to the center of the hinge line.



7. Cut the covering from the control horn slot on the bottom of the aileron. Fit the plywood control horn to the pushrod. Fit the control horn in the slot. Make sure that the arm is centered with the radio on and the trim centered. Align the aileron TE and wing TE, then glue the control horn to the aileron with thin CA.



8. Trim the plastic aileron servo cover and place over the servo. Check that the cover does not interfere with the movement of the servo. Tape the cover to the wing.

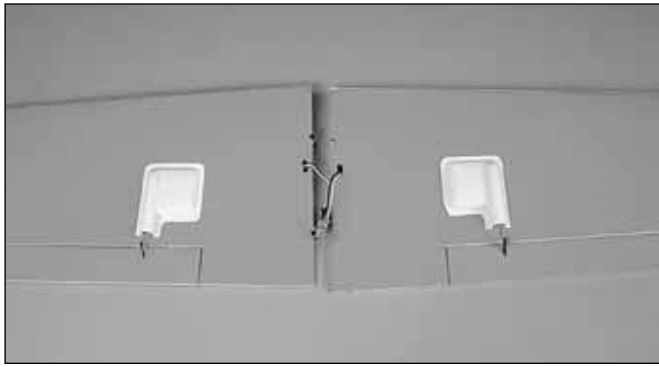

- ❑ 9. Repeat steps 1-8 for the other wing half.

Join the Wing

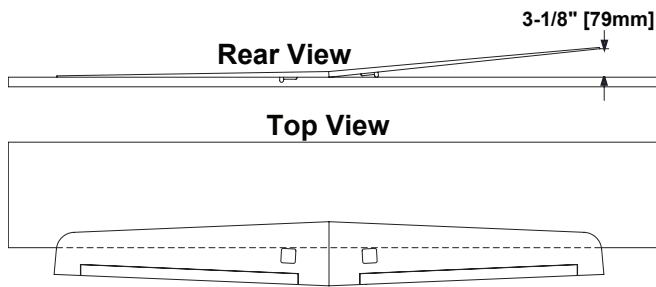

- ❑ 1. With the front half of the left wing flat on your workbench and the center joint on wax paper, raise the right wing tip 3-1/8" [79mm] to properly set the dihedral. Block the raised right wing at the desired height and make a mental note of the position needed for it to maintain that dihedral.

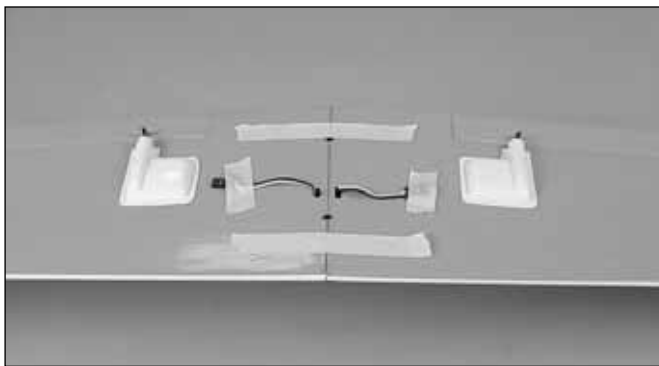

- ❑ 2. Remove the joiner from the wings. Cover the joint, left and right wing ribs and pockets in the wing panels with a moderate, but not excessive, amount of 30-minute epoxy. Join the wing halves together. Ensure that the left wing remains flat and that the right wing tip is 3-1/8" [79mm] from your work bench and can remain that way undisturbed until the epoxy has hardened. Remove any excess epoxy with a paper towel and denatured alcohol, being careful not to disturb the joint. **Hint:** Use masking tape to hold the wing together while the epoxy hardens.

ASSEMBLE THE FUSELAGE

Canopy Removal

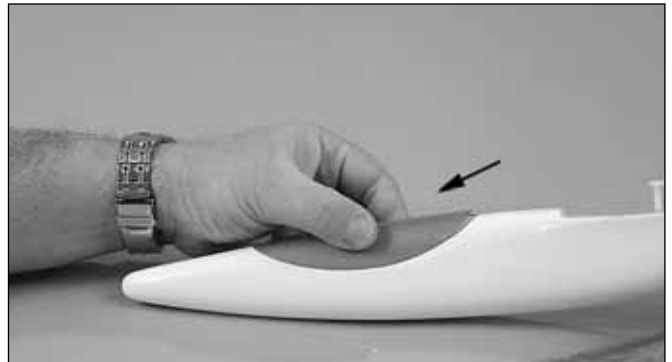

- ❑ 1. Slide the **canopy** forward.

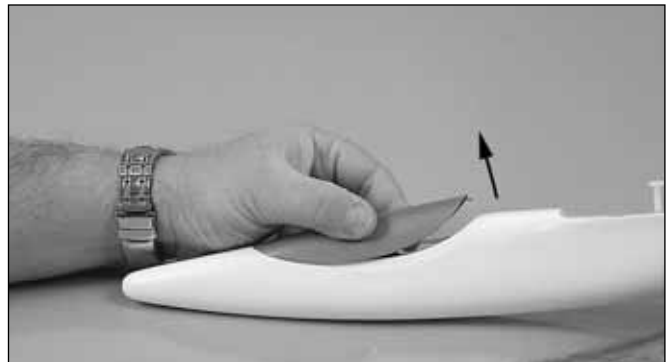

- ❑ 2. Lift the rear of the canopy so the wire clears the fuse.

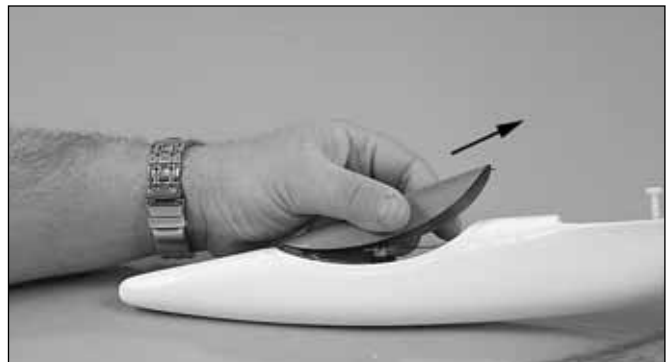

- ❑ 3. Slide the canopy aft until the front wire releases.

- ❑ 4. To attach the canopy, reverse the previous steps.

Attach the Tail

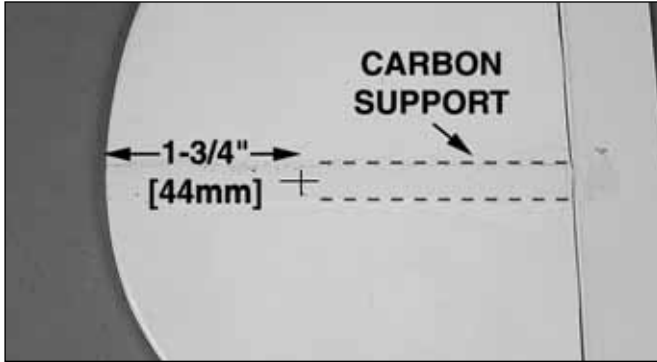

1. Mark the fin 1-3/4" [44mm] from the LE and centered on the carbon supports.

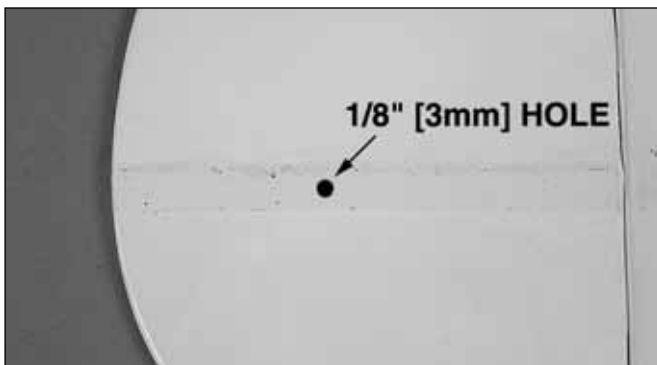

2. Drill a 1/8" [3mm] hole through the fin on the mark you made.



3. Bolt the wing to the fuse with the two 8-32 x 1-1/4" [30mm] nylon bolts.

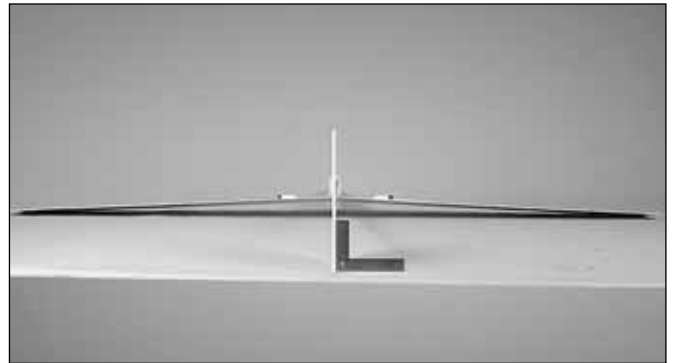
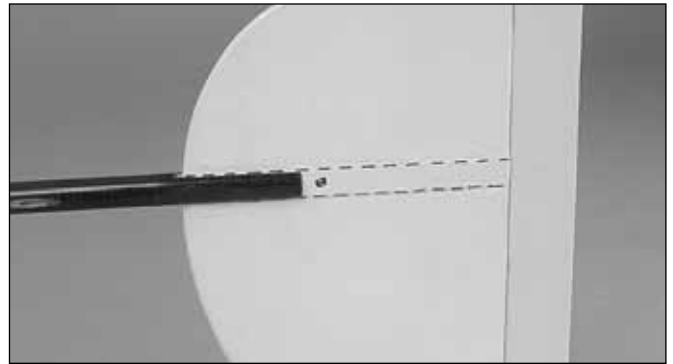

4. Place the plane upside down on a flat work surface. Align the carbon support in the fin with the carbon fuse. Check that the fin is perpendicular to the work surface. If the fin is not perpendicular adjust the fin slot so that it is perpendicular. Glue the fin to the fuse with thin CA. **DO NOT** remove the covering from the fin.

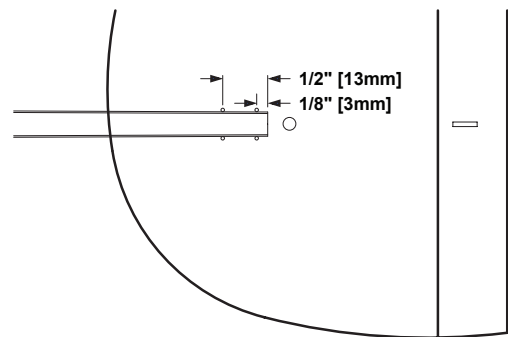

5. Drill four 1/16" [1.6mm] holes in the locations shown in the sketch.

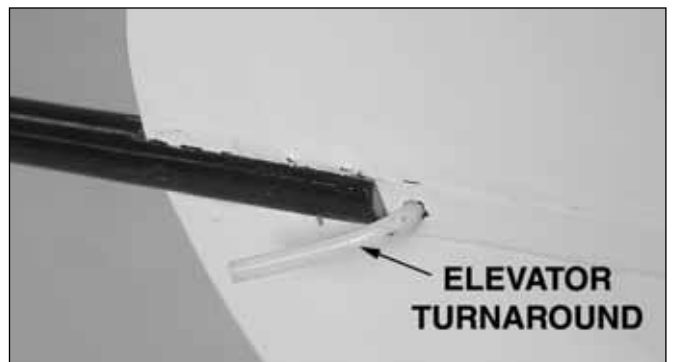

6. Slide the plastic elevator turnaround through the 1/8" [3mm] hole in the rudder.

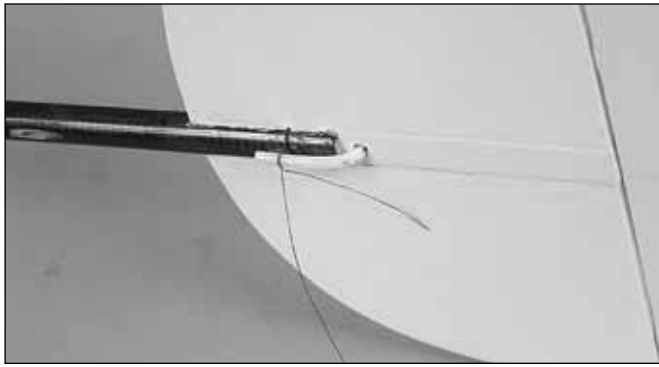

7. Cut an 8" [200mm] piece of pushrod string. Loop it through the forward hole and around the carbon fuse and the elevator turnaround twice. Pull elevator turnaround to the fuse with the string and secure with thin CA.



8. Pull the remaining string through the rear hole and loop it around the fuse and elevator turnaround as many times as possible. Pull the string tight and secure it with thin CA.

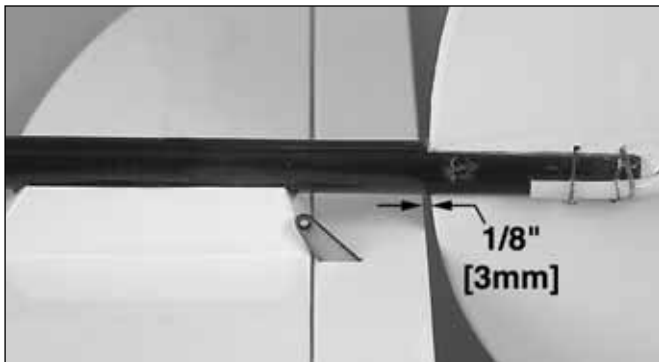
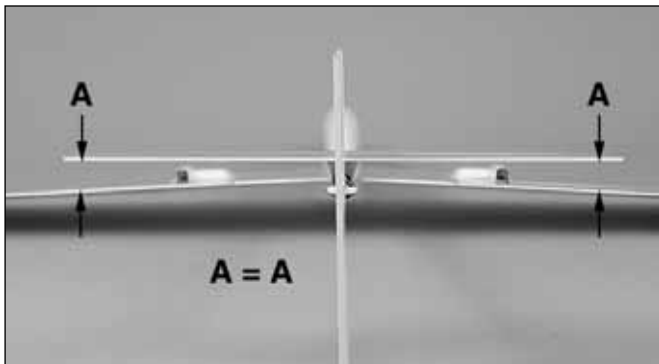

9. Glue the stab to the fuse, making sure it is aligned with the wing and that the TE of the elevator is 1/8" [3mm] in front of the fin.

Install the Rudder & Elevator Servos

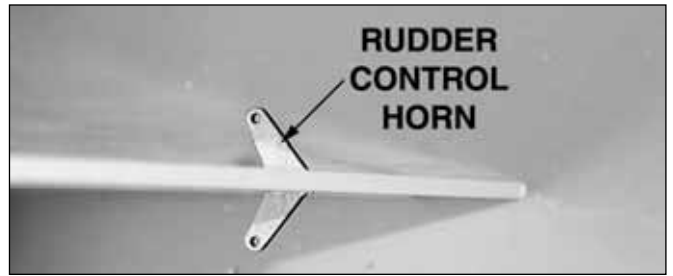

1. Trim the covering and slide the two sided plywood control horn through the rudder, center it and then glue it with thin CA.

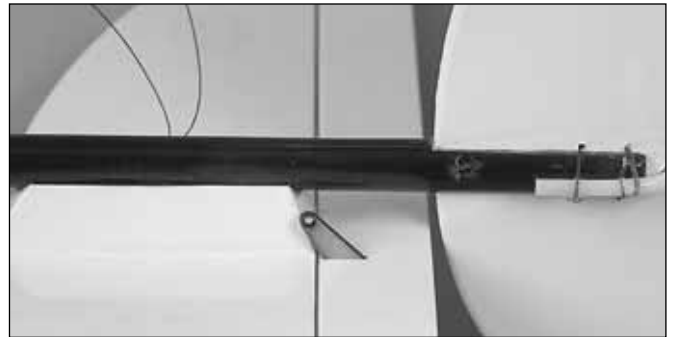

2. Slide the single sided plywood control horn into the elevator and glue with thin CA.

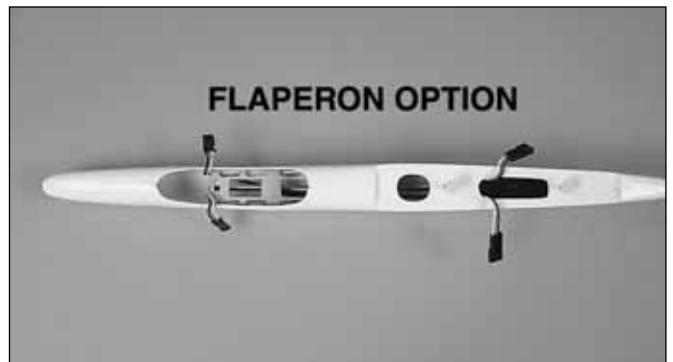

3. Install the aileron extensions under the servo tray.

A. If you will be utilizing flaperon mixing install two 12" [300mm] servo leads.

OR

B. If you will be using the ailerons just as ailerons install a Y-harness.

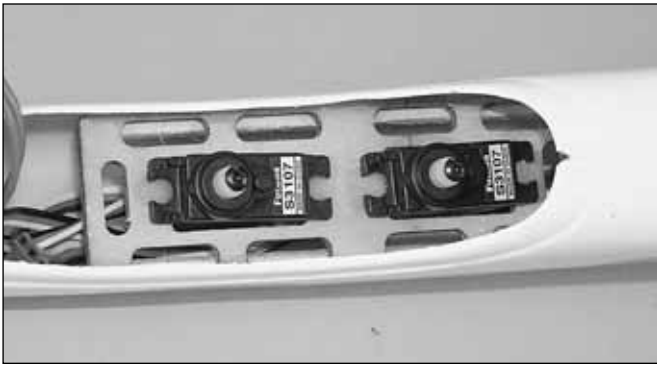

4. Mount the servos to the servo tray. **Optional:** To keep the weight low, use a drop of medium CA through each servo screw hole instead of the servo screws.

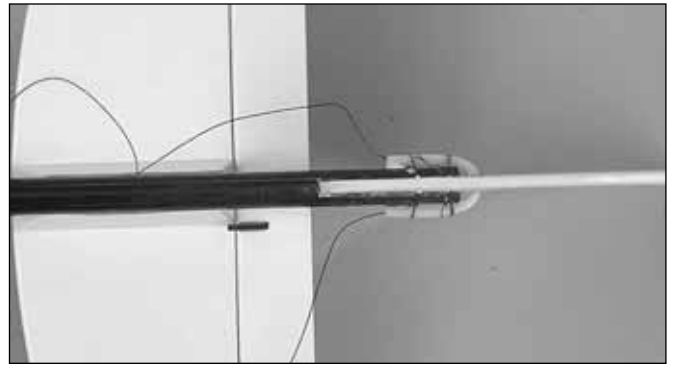

8. Slide the cut string that is on the right side of the fuse through the elevator turnaround.

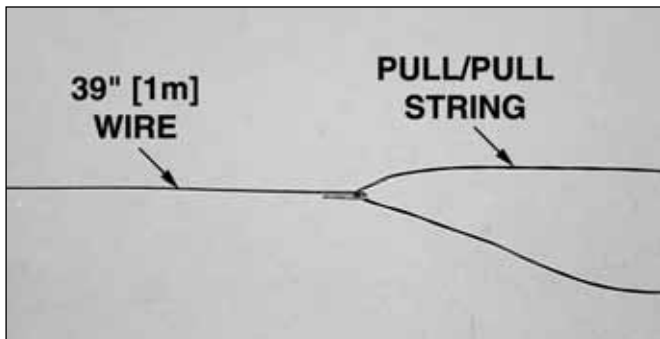

5. Hook the 39" [1m] wire to the center of the remaining pushrod string. Pull the strings back through the left plastic pushrod tube around the rudder and forward through the right pushrod tube.

9. Plug the servos and battery into your receiver. Turn on the transmitter to center the rudder and elevator servos.

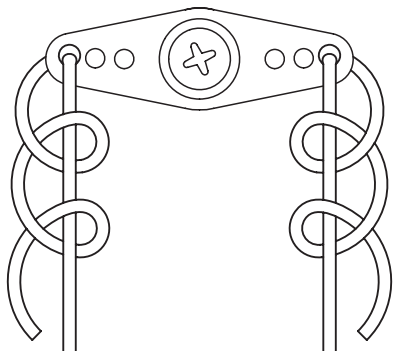

6. Tie the strings to the servo arms and secure with a small drop of thin CA.



10. Tie the cut ends of the string to the elevator control horn. The strings need to have some tension on them and the elevator needs to be aligned with the stab. After you have confirmed that the elevator is straight and moves full throw of the servo secure the knots with a drop of thin CA.



7. Pull one of the strings on the left side and cut it midway back on the fin.

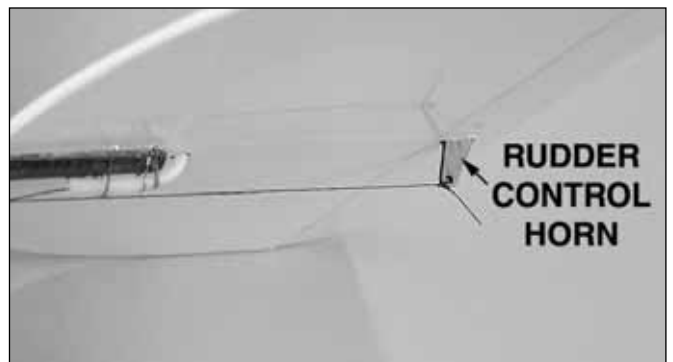

11. Attach the rudder strings to the control horn, being sure to keep the rudder straight and the strings tight.

FINAL INSTALLATION & CG

Install the Throwing Peg



- 1. If you are **right handed**, remove the covering from the hole in the **left wing tip**. If you are **left handed**, remove the covering from the hole in the **right wing tip**.

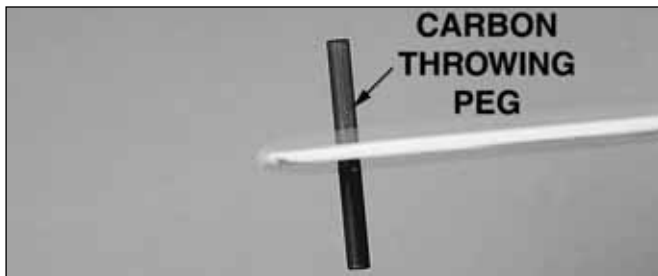

- 2. Push the 3/16" x 2" [5 x 50mm] carbon throwing peg into the hole in the wing tip. Apply a small amount of epoxy to the peg and twist the peg so that the epoxy goes into the wing and the peg is centered vertically in the wing.

Set the CG

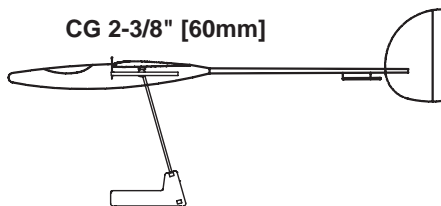

- 1. Accurately mark the balance point on the bottom of the wing on both sides of the fuselage. The balance point is located **2-3/8" [60mm] back from the leading edge, at the fuselage**. This is the balance point at which your model should balance for your first flights. Later, you may wish to experiment by shifting the balance up to 1/8" [3mm] forward or 1/8" [3mm] back to change the flying characteristics. Moving the C.G. forward will add some stability but it will decrease the overall performance of the sailplane. Moving the balance back makes the model more agile with a lighter and snappier "feel" and improves the sailplane's response to air currents. In any case, please start at the location we recommend and do not at any time balance your model outside the recommended range.

- 2. Temporarily place the battery and Rx in the fuse, and mount the wing and canopy. Add the necessary weight to make the plane balance at 2-3/8" [60mm]. We found the best way to do this is to mix steel shot with epoxy and then pour the correct amount into the nose. Work in small increments of weight, double checking the CG each time.

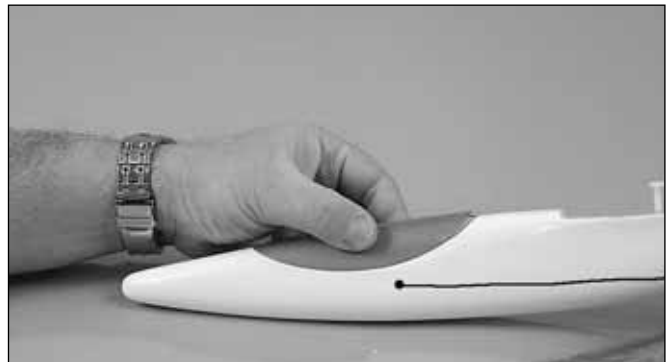

- 3. Route the antenna outside the fuselage and tape it to the carbon fiber rod.

Apply the Decals

1. Use scissors or a sharp hobby knife to cut the decals from the sheet.
2. Be certain the model is clean and free from oily fingerprints and dust. Prepare a dishpan or small bucket with a mixture of liquid dish soap and warm water—about one teaspoon of soap per gallon of water. Submerge the decal in the soap and water and peel off the paper backing.
Note: Even though the decals have a "sticky-back" and are not the water transfer type, submersing them in soap & water allows accurate positioning and reduces air bubbles underneath.
3. Position the decal on the model where desired. Holding the decal down, use a paper towel to wipe most of the water away.
4. Use a piece of soft balsa or something similar to squeegee remaining water from under the decal. Apply the rest of the decals the same way.

GET THE MODEL READY TO FLY

Check the Control Directions

- 1. Turn on the transmitter and receiver and center the trims. If necessary, remove the servo arms from the servos and reposition them so they are centered. Reinstall the screws that hold on the servo arms.
- 2. With the transmitter and receiver still on, check all the control surfaces to see if they are centered. If necessary, adjust the clevises on the pushrods to center the control surfaces.

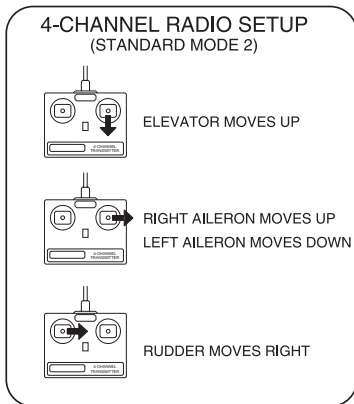

3. Make certain that the control surfaces respond in the correct direction as shown in the diagram. If any of the controls respond in the wrong direction, use the servo reversing in the transmitter to reverse the servos connected to those controls. Be certain the control surfaces have remained centered. Adjust if necessary.

Set the Control Throws

Use a Great Planes AccuThrow™ (or a ruler) to accurately measure and set the control throw of each control surface as indicated in the chart that follows. If your radio does not have dual rates, we recommend setting the throws at the high rate setting.

These are the recommended control surface throws

	Low Rate	High Rate
ELEVATOR	1/4" [6mm] up 1/4" [6mm] down	3/8" [9.5mm] up 3/8" [9.5mm] down
AILERONS	3/8" [9.5mm] up 3/8" [9.5mm] down	5/8" [16mm] up 5/8" [16mm] down
RUDDER	1/4" [6mm] right 1/4" [6mm] left	3/8" [9.5mm] right 3/8" [9.5mm] left

IMPORTANT: The Fling DL ARF has been **extensively** flown and tested to arrive at the throws at which it flies best. Flying your model at these throws will provide you with the greatest chance for successful first flights. If, after you have become accustomed to the way the Fling DL ARF flies, you would like to change the throws to suit your taste, that is fine. However, too much control throw could make the model difficult to control, so remember, "more is not always better."

Balance the Model Laterally

1. With the wing level, have an assistant help you lift the model by the tip of the fuse and the bottom of the fin. Do this several times.

2. If one wing always drops when you lift the model, it means that side is heavy. Balance the airplane by adding weight to the other wing tip. **An airplane that has been laterally balanced will track better in loops and other maneuvers.**

PREFLIGHT

Identify Your Model

No matter if you fly at an AMA sanctioned R/C club site or if you fly somewhere on your own, you should always have your name, address, telephone number and AMA number on or inside your model. It is **required** at all AMA R/C club flying sites and AMA sanctioned flying events. Fill out the identification tag on the back cover and place it on or inside your model.

Charge the Batteries

Follow the battery charging instructions that came with your radio control system to charge the batteries. You should always charge your transmitter and receiver batteries the night before you go flying, and at other times as recommended by the radio manufacturer.

CAUTION: Unless the instructions that came with your radio system state differently, the **initial** charge on **new** transmitter and receiver batteries should be done for 15 hours **using the slow-charger that came with the radio system.** This will "condition" the batteries so that the next charge may be done using the fast-charger of your choice. If the initial charge is done with a fast-charger, the batteries may not reach their full capacity and you may be flying with batteries that are only partially charged.

Range Check

Ground check the operational range of your radio before the first flight of the day. With the transmitter antenna collapsed and the receiver and transmitter on, you should be able to walk at least 100 feet away from the model and still have control. Have an assistant stand by your model and, while you work the controls, tell you what the control surfaces are doing. If the control surfaces do not respond correctly, **do not fly!** Find and correct the problem first. Look for loose servo connections or broken wires, corroded wires on old servo connectors, poor solder joints in your battery pack or a defective cell, or a damaged receiver crystal from a previous crash.

AMA SAFETY CODE (EXCERPTS)

General

Read and abide by the following excerpts from the Academy of Model Aeronautics Safety Code. For the complete Safety Code refer to *Model Aviation* magazine, the AMA web site or the Code that came with your AMA license.

- 1) I will not fly my model aircraft in sanctioned events, air shows, or model flying demonstrations until it has been proven to be airworthy by having been previously, successfully flight tested.
- 2) I will not fly my model aircraft higher than approximately 400 feet within 3 miles of an airport without notifying the airport operator. I will give right-of-way and avoid flying in the proximity of full-scale aircraft. Where necessary, an observer shall be utilized to supervise flying to avoid having models fly in the proximity of full-scale aircraft.
- 3) Where established, I will abide by the safety rules for the flying site I use, and I will not willfully and deliberately fly my models in a careless, reckless and/or dangerous manner.
- 5) I will not fly my model unless it is identified with my name and address or AMA number, on or in the model. Note: This does not apply to models while being flown indoors.
- 7) I will not operate models with pyrotechnics (any device that explodes, burns, or propels a projectile of any kind).

Radio Control

- 1) I will have completed a successful radio equipment ground check before the first flight of a new or repaired model.
- 2) I will not fly my model aircraft in the presence of spectators until I become a qualified flier, unless assisted by an experienced helper.
- 3) At all flying sites a straight or curved line(s) must be established in front of which all flying takes place with the other side for spectators. Only personnel involved with flying the aircraft are allowed at or in the front of the flight line. Intentional flying behind the flight line is prohibited.
- 4) I will operate my model using only radio control frequencies currently allowed by the Federal Communications Commission.
- 5) **I will not knowingly operate my model within three miles of any pre-existing flying site except in accordance with the frequency sharing agreement listed** [in the complete AMA Safety Code].

CHECK LIST

During the last few moments of preparation your mind may be elsewhere anticipating the excitement of the first flight. Because of this, you may be more likely to overlook certain checks and procedures that should be performed before the model is flown. To help avoid this, a check list is provided to make sure these important areas are not overlooked. Many are covered in the instruction manual, so where appropriate, refer to the manual for complete instructions. Be sure to check the items off as they are completed.

1. Check the C.G. according to the measurements provided in the manual.
2. Extend your receiver antenna and make sure it has a strain relief inside the fuselage to keep tension off the solder joint inside the receiver.
3. Balance your model *laterally* as explained in the instructions.
4. Make sure all hinges are **securely** glued in place.
5. Confirm that all controls operate in the correct direction and the throws are set up according to the manual.
6. Make sure any servo extension cords you may have used do not interfere with other systems (servo arms, pushrods, etc.).
7. Place your name, address, AMA number and telephone number on or inside your model.
8. Cycle your receiver battery pack (if necessary) and make sure it is fully charged.
9. If you wish to photograph your model, do so before your first flight.
10. Range check your radio when you get to the flying field.

FLYING

Launching

The launch shown in the diagram and pictures assumes a right handed launch with the wind going from right to left. This launch style is not difficult and with just a little practice launches of over 100 feet are easily achieved.

Note: To view a movie of an actual launch go to:
<http://www.greatplanes.com/airplanes/gpma1070.html>

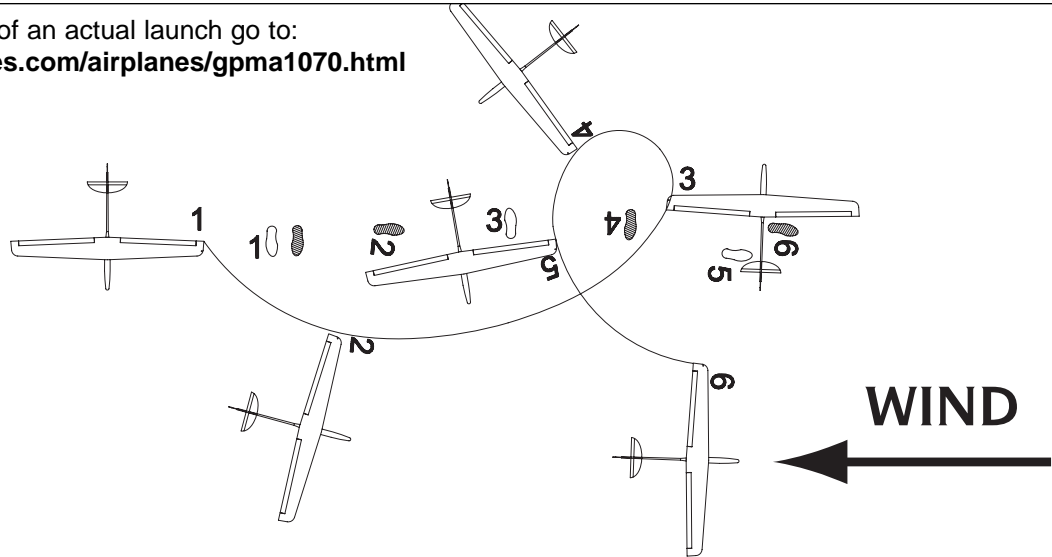

Grip

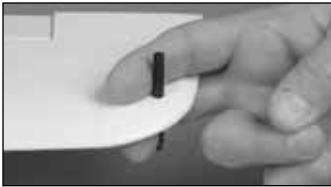

Your right index finger and middle finger should be wrapped around the peg.

Start position



Foot position 1:
Stand with your left shoulder into the wind and the right wing tip on the ground.

Transition



Foot position 2:
Take a long step with your left foot pulling the plane up and forward with your right arm.

Rotation



Foot position 3:
Start rotating to the left keeping the plane flat and your arm extended.

Stroke



Foot position 4:

This is the second half of the rotation and the section that is most responsible for a good high launch. Do not use too much arm in this section. Just let the rotation of your torso speed the plane up.

Release



Foot position 5:

By this time in the launch the plane will be trying to climb on its own. Just release your fingers and let the plane fly out of your hand. Try to release it directly into the wind.

Recovery



Foot position 6:

This last step is just to catch your balance and watch your plane climb for the clouds.

The push

The plane will climb between 60 and 80 degrees after release. When the plane has slowed almost to the point of stopping push full down elevator to achieve level flight. When this is done at the right moment the plane will go into horizontal flight with just enough airspeed to maintain level flight. If it is done too early the plane will balloon from horizontal flight. If it is done too late the plane will tail slide.

THERMAL FLYING

Thermal soaring is one of the most intriguing of all aspects of flying and the Fling DL ARF was designed to excel at thermal soaring even in the hands of a novice. It can be hard for the average person to understand how a plane can fly for hours and gain altitude **without a motor!**

Facts about Thermals

Thermals are a natural phenomenon that happen outside, by the millions, every single day of the year. Thermals are responsible for many things including forming several types of clouds, creating breezes, and distributing plant seeds and pollen. If you have ever seen a dust devil (which is nothing more than a thermal that has picked up some dust), you have seen a thermal in action. Their swirling action is very similar to that of a tornado but of course much gentler. Most thermals have updrafts rising in the 200 – 700 feet per minute range but they have been known to produce updrafts of over 5,000 feet per minute (that's over 50 miles/hour straight up!) These strong thermals can rip a plane apart or carry the plane out of sight before the pilot can get out of the updraft.

Thermals are formed by the uneven heating of the earth and buildings, etc. by the sun. The darker colored surfaces absorb heat faster than the lighter colors, which reflect a great deal of the sun's energy back into space. These darker areas (plowed fields, asphalt parking lots, tar roofs, etc.) get warmer than the lighter areas (lakes, grassy fields, forests, etc.). This causes the air above the darker areas to be warmer than the air over the lighter areas and the more buoyant warm air rises as the cooler, denser air forces its way underneath the warmer air. As this warm air is forced upward, it contacts the cooler air of the higher altitudes and this larger temperature difference makes the thermal rise quicker. The thermal is gradually cooled by the surrounding cooler air and its strength diminishes. Eventually the thermal stops rising and any moisture contained in the once warm air condenses and forms a puffy cumulus cloud. These clouds, which mark the tops of thermals, are usually between 2000 and 5000 feet high.

Thermal Soaring

It takes a lot of concentration to thermal soar effectively. A sailplane can fly along the edge of a thermal and unless the pilot is carefully watching the model he may not realize the opportunity to gain some altitude. Because most thermals are relatively small (a couple hundred feet in diameter or less at 400' altitude) compared to the rest of the sky, the sailplanes will rarely fly directly into the thermal and start rising. Generally, the sailplane will fly into the edge or near a thermal and the effects the thermal has on the plane may be **almost** unnoticeable. As the sailplane approaches a thermal, the wing tip that reaches the rising air first will be lifted before the opposite wing tip. This causes the plane to "bank" and turn away from where we would like the plane to go.

When you are thermal soaring, try to fly as smoothly and straight as possible. Trim the plane to fly in a straight line and **only** touch the controls when you have to. Watch the sailplane carefully and it will tell you what it is encountering.

When the sailplane flies directly into a thermal it will either start rising or stop sinking. Either case is reason enough to start circling (especially in a contest where every second counts). Fly straight ahead until you feel like you are in the strongest lift, **fly a couple of seconds farther** (so your circle will be centered in the strongest lift) and then start circling in a fairly tight but **smooth** turn. When the sailplane is low the turns have to be tighter to stay in the strongest lift. As the plane gains altitude, the turns can be larger and flatter. The flatter the turn, the more efficient the plane is flying, but don't be afraid to really "crank" it into a steep bank when you are low. If you see the plane falling off on one side of the turn, move your circle over into the stronger lift. Thermals move along with the wind so as you circle you will be swept along with it. Be careful when thermaling, that you don't get so far downwind you can't make it back to the field to land.

If the sailplane is flying along straight and all of a sudden turns, let the plane continue to bank (you may have to give it some rudder to keep it banking) until it has turned 270-degrees (3/4 of a full circle). Straighten out the bank and fly into whatever turned the plane. If you encounter lift, and you won't every time, start circling just as you did when flying directly into a thermal.

Thermals are generated all day long, but the strongest thermals are produced when the sun is directly overhead. 10:00 am – 2:00 pm seems to be the best time to get those "killer" thermals. Some of these thermals can be very large and you may find it hard to get out of them. If you find yourself getting too high, don't dive the plane to get out of the lift. Sailplanes are very efficient aircraft and they will build up a lot of speed and could "blow up" in the rough air of a thermal. The easiest way to lose altitude is to apply full rudder and full up elevator. This will put the plane into a tight spin that will not over stress the airframe but it will enable it to lose altitude very quickly. This is especially helpful if the sailplane gets sucked into a cloud or it gets too high to see. The twirling action will give the sun a better chance of flashing off of the wing and catching your attention. When you are high enough and want to leave the thermal, add a little down trim to pick up some speed and fly 90 degrees to the direction of the wind. If you are not real high and want to find another thermal, you may want to look upwind of the last thermal. The same source that generated this thermal is probably producing another. Just watch out for "sink" which is often found behind and between thermals.

As you might expect, with all this air rising, there is also air sinking. This air is the sailplane pilot's nightmare that can really make soaring challenging. "Sink" is usually not as strong as the thermals in the same area, but it can be very strong. Down drafts of many hundreds of feet per minute are common on a good soaring day. These down drafts can

make a sailplane look like it is falling out of the air. Because of this, it is important that you do not let the sailplane get too far downwind.

When encountering sink, immediately turn and fly 90 degrees to the direction of the wind (towards you if possible). Apply a little “down elevator” and pick up some speed to get out of the sink as fast as possible. Every second you stay in the sink is precious altitude lost.

Slope Soaring

Slope soaring is a type of flying that is very popular in hilly regions and along the coasts. This type of soaring is possible when the wind is blowing directly up a hill or cliff. As the wind hits the slope it is forced up, producing lift which can be utilized by real sailplanes, hang gliders, birds and even model sailplanes. To be able to slope soar, you need a slope with a smooth piece of land (or water) out in front of it and a breeze blowing pretty close to straight up the slope. The higher and steeper the hill or cliff the better. Also the larger and smoother the land out in front the better. The air flowing along hits the hill, is forced up and can generate a very large area of lift. Behind the hill is a large area of

turbulent air that can be very dangerous to try to fly in. The faster the wind is blowing, the stronger the lift and turbulence will be. To fly off a slope, stand near the edge and throw the sailplane (nose down) into the wind. As the sailplane flies out into the “band” of lift it will begin to gain altitude. Turn and fly parallel to the slope and make all of your turns into the wind (especially when you are close to the slope). You will be surprised at the altitude you can gain just from slope lift. Thermals will often be “popped loose” by these slopes. If you catch a thermal and follow it downwind, be very careful to stay high enough to make it back to the slope without flying through the turbulent air behind the slope. If you don’t have enough altitude you may want to land a good distance behind the slope if possible to avoid this turbulent air.

Slope Landings

Landings can be very tricky on some slopes. On gentle slopes you can often fly very close to the top of the slope and “slide” into the top of the slope without encountering any turbulent air. On steeper slopes you may have to be a little more aggressive to get the plane out of the lift. In any case it is a good idea to plan your landing before launching your plane.

Have a ball! But always stay in control and fly in a safe manner.

GOOD LUCK AND GREAT FLYING!

COMPLETE THE TAG BELOW AND PUT IT IN YOUR MODEL.

This model belongs to:

Name

Address

City, State Zip

Phone number

AMA number