

# REFLECTION™ *ARF*

## INSTRUCTION MANUAL



**Wingspan:** 27.5 in [700mm]  
**Wing Area:** 400 sq in [25.8 dm<sup>2</sup>]  
**Weight:** 9.5 – 11 oz [270 – 310g]  
**Wing Loading:** 4 oz/sq ft [10g/dm<sup>2</sup>]  
**Length:** 31 in [785mm]  
**Radio:** 4-channel w/3 micro servos and 10-Amp ESC  
**Power System:** Included ElectriFly™ T-370 motor with 5:1 ratio gearbox,  
or optional direct-drive RimFire™ Brushless motor

designed by Greg Ward

### WARRANTY

Great Planes® Model Manufacturing Co. guarantees this kit to be free from defects in both material and workmanship at the date of purchase. This warranty does not cover any component parts damaged by use or modification. **In no case shall Great Planes' liability exceed the original cost of the purchased kit.** Further, Great Planes reserves the right to change or modify this warranty without notice.

In that Great Planes has no control over the final assembly or material used for final assembly, no liability shall be assumed nor accepted for any damage resulting from the use by the user of the final user-assembled product. By the act of using the user-assembled product, the user accepts all resulting liability.

**If the buyer is not prepared to accept the liability associated with the use of this product, the buyer is advised to return this kit immediately in new and unused condition to the place of purchase.**

To make a warranty claim send the defective part or item to Hobby Services at the address below:

Hobby Services  
3002 N. Apollo Dr., Suite 1  
Champaign, IL 61822 USA

Include a letter stating your name, return shipping address, as much contact information as possible (daytime telephone number, fax number, e-mail address), a detailed description of the problem and a photocopy of the purchase receipt. Upon receipt of the package the problem will be evaluated as quickly as possible.

**READ THROUGH THIS MANUAL BEFORE STARTING CONSTRUCTION. IT CONTAINS IMPORTANT WARNINGS AND INSTRUCTIONS CONCERNING THE ASSEMBLY AND USE OF THIS MODEL.**



Champaign, Illinois  
(217) 398-8970, Ext 5  
airsupport@greatplanes.com

## TABLE OF CONTENTS

INTRODUCTION .....	2
SAFETY PRECAUTIONS .....	2
AMA .....	3
DECISIONS YOU MUST MAKE .....	3
ADDITIONAL ITEMS REQUIRED .....	4
KIT INSPECTION .....	5
KIT CONTENTS .....	5
ORDERING REPLACEMENT PARTS .....	6
METRIC/INCH RULER .....	6
BUILD THE AIRPLANE .....	7
GET THE MODEL READY TO FLY .....	18
Check the Control Directions .....	18
Set the Control Throws .....	18
Balance the Model (C.G.) .....	19
Balance the Model Laterally .....	19
PREFLIGHT .....	19
Identify Your Model .....	19
Charge the Batteries .....	19
Range Check .....	20
MOTOR SAFETY PRECAUTIONS .....	20
AMA SAFETY CODE (excerpts) .....	20
CHECK LIST .....	20
FLYING .....	21
Hand Launch .....	21
Rise-Off-Ground (ROG) Takeoffs .....	21
Flight .....	21
Landing .....	21
ANGLE TEMPLATES .....	23

## INTRODUCTION

The ElectriFly™ by Great Planes FlatOut Reflection ARF is an excellent way to enjoy 3D aerobatics without the cost and headaches of giant-scale gasoline-powered models. A couple of hours on the workbench, and your FlatOut Reflection ARF will be ready to tackle torque rolls, walls, harriers, high-alpha rolling circles and more! An excellent indoor or calm-day outdoor performer, this airplane is a virtually unlimited 3D aerobat, but flying it involves only connecting the battery, throttling up, and letting go!

Take care to build straight and true. Misaligned parts will decrease the airplane's ability to perform the extreme aerobatics it is designed for.

For the latest technical updates or manual corrections to the FlatOut Reflection ARF visit the Great Planes web site at [www.electrifly.com](http://www.electrifly.com). Open the "Airplanes" link, then select the FlatOut Reflection ARF. If there is new technical information or changes to this model a "tech notice" box will appear in the upper left corner of the page.

**CAUTION:** Be aware that the FlatOut Reflection ARF is operated on the same frequency band as larger, "regular" R/C models. If flying your FlatOut Reflection ARF within five miles of an R/C site, there is a real possibility that you could be operating your model on the same frequency (channel) as another R/C pilot. If this happens a crash will result—with the person flying the more expensive model suffering the greater loss (and having greater potential for property damage or injury). The best thing to do is to join an R/C club and fly at the site where frequency control measures will be in effect. If you insist on flying elsewhere **always be aware of your proximity to R/C flying sites.**

### A NOTE ABOUT METRIC DIMENSIONS

Since the parts of this airplane have been designed with metric dimensions, the metric size (in millimeters) of the parts is listed first in the text. For convenience, we have listed close approximations of these sizes in the English system (inches), but be aware that these conversions are only approximate.

## PROTECT YOUR MODEL, YOURSELF & OTHERS...FOLLOW THESE IMPORTANT SAFETY PRECAUTIONS



**Attention:** The product you have purchased is powered by a rechargeable battery. At the end of its useful life, under various state and local laws, it may be illegal to dispose of this battery into the municipal waste system. Check with your local solid waste officials for details in your area for recycling options or proper disposal.

**This product contains a chemical known to the state of California to cause cancer and birth defects or other reproductive harm.**

1. Even though the FlatOut Reflection ARF is small, lightweight and flies slowly, if it is not assembled and operated correctly it could possibly cause injury to yourself or spectators and damage property.
2. Build the plane **according to the instructions**. Do not alter or modify the model, as doing so may result in an unsafe or unflyable model.
3. Use an R/C radio system and components that are in first-class condition. The FlatOut Reflection ARF requires specialized radio gear. Refer to "**DECISIONS YOU MUST MAKE**" section to get an accurate description of the specialized gear required.
4. You must properly install all R/C and other components so that the model operates correctly on the ground and in the air.

5. You must test the operation of the model before **every** flight to insure that all equipment is operating, and that the model has remained structurally sound. Be sure to check connectors often and replace them if they show signs of wear or fatigue.

**Note:** We, as the kit manufacturer, provide you with a top quality kit and great instructions, but ultimately the quality and flyability of your finished model depends on how you build it; therefore, we cannot in any way guarantee the performance of your completed model, and no representations are expressed or implied as to the performance or safety of your completed model.

**Remember: Take your time and follow directions to end up with a well-built model that is straight and true.**

## AMA

If you're not already an **AMA** (Academy of Model Aeronautics) member, we highly recommend that you join. In addition to providing liability protection while operating under the AMA Safety Code, the AMA is the governing body of model aeronautics in the United States and fights for your rights as member of the modeling community. You must also be an AMA member to fly at R/C clubs chartered by the AMA—most of which are.

Contact the AMA at the address or toll-free phone number below.



**Academy of Model Aeronautics**  
 5151 East Memorial Drive  
 Muncie, IN 47302  
 Tele: (800) 435-9262  
 Fax (765) 741-0057  
 Or via the Internet at:  
<http://www.modelaircraft.org>

## DECISIONS YOU MUST MAKE

In the hands of a capable pilot the FlatOut Reflection ARF is an impressive 3D performer. But for the FlatOut Reflection ARF to perform to its full potential, it must be properly equipped with all the correct gear (servos, batteries, receiver, speed control). There may be more than one type and brand of radio equipment that can be used, but based on extensive testing, following is the equipment we recommend so you can get the most performance out of your FlatOut Reflection ARF and assemble it as shown in this instruction manual.

### Transmitter

With a standard, four-channel radio the FlatOut is capable of all the basic 3D maneuvers. However, some advanced pilots who are already familiar with handling “flat foamies” may prefer to fly the FlatOut with a computer radio capable of endpoint adjustments (for fine-tuning control throws), exponentials (for “softening” the throws near the center of the travel), and various mixing functions (such as rudder-to-elevator mixing for extended knife-edge flight).

### Servos

The FlatOut Reflection ARF requires three *sub-micro* servos with a maximum weight of .3 oz [9g] each and a minimum torque rating of 15 oz-in. [2kg-cm] Futaba® S-3108M (micro connector) servos (FUTM0700) are ideal because they meet the torque and weight requirements and have a micro connector that is compatible with the Futaba *Ultra Micro* receiver. Although there may be other servos that will physically fit in the model, those outside the recommended weight and torque specifications will adversely affect flight performance and are not recommended. **Note:** During assembly when it's time to mount the servos, you will be instructed to glue them in. Do not be alarmed as this is a common practice with this type of lightweight, high-performance model. Should servo removal ever be necessary for repair, replacement or transfer to another model this can be done by prying them out with a hobby knife or a small screwdriver.

### Receiver

The lightest, four-channel receiver is recommended and must be compatible with whatever servos will be used (not all servos are compatible with all receivers—even servos and receivers within the same brand). The Futaba R-124F *Ultra Micro* receiver is recommended and is compatible with the 3108M servos recommended. **Note:** Futaba receivers are sold on high and low bands and come without crystals. Following are the order numbers for the R-124F receiver and compatible crystals:

	<b>Low Band (Channels 11-35)</b>	<b>High Band (Channels 36-60)</b>
<b>R124F Receiver</b>	FUTL0438	FUTL0439
<b>Crystal</b>	FUTL62**	FUTL63**

\*\*Replace the “\*\*” in the order number for the crystals with the preferred channel number. For example, if you want to fly on channel 33, order a low band receiver and crystal number FUTL6233.

## Battery

The FlatOut Reflection ARF requires a 3-cell (11.1V), 350-700mAh lithium-polymer (Li-Po) battery capable of providing 7A continuous discharge current. The ElectriFly 3-cell, 3-Series 640mAh battery pack is recommended (GPMP0805). **Note:** The ElectriFly 720mAh battery is not recommended for this model as it is not capable of delivering the current required by this system. For optimum performance battery weight should not exceed 2.5 oz. [54g].

## Speed Control

An electronic speed control capable of handling a minimum of 7A continuous current is required. Additionally, the speed control should be as light as possible. The ElectriFly C-10 *Micro* High-Frequency ESC w/BEC (GPMM2010) is suitable. If upgrading to the optional brushless motor system recommended (below), a speed control intended for brushless motors (a *brushless* speed control) capable of at least 8A continuous current such as the ElectriFly BL-8 (GPMM2070) must be used. **NEVER use speed controllers intended for brushed motors on brushless motors (and vice-versa).**

## Charger

A charger capable of charging 3-cell (11.1V) Li-Po batteries such as the ElectriFly Polycharge 1-3-cell Li-Po charger (GPMM3010) must be used. If using another charger, it **must** be a Li-Po charger or have a Li-Po charge mode. Never charge Li-Po batteries with chargers not intended for Li-Po batteries or chargers on NiMH or NiCd settings. Overcharging or explosion may result. In addition to the Polycharge, the ElectriFly Triton™ (GPMM3150) or Accu-Cycle Elite™ (HCAP0280) is also suitable chargers.

## Battery Charging Leads

Many chargers (including the Triton and Accu-Cycle Elite listed above) do not include charging leads, but rather have banana jacks to plug the leads into. If this is the case with your charger, you will need to purchase a charge lead to match your battery. For the recommended 640mAh pack, the correct lead is GPMM3105.

## Optional: Brushless Motor Upgrade

Rest assured, the FlatOut Reflection ARF is capable of 3D flight with the included ElectriFly “stick-mount” motor and gearbox combination. But for pilots who always insist on upgrading and don’t mind spending a little extra money, the ElectriFly Rimfire 22M-1000 brushless motor (GPMG4500) will provide increased power and flight time while simultaneously reducing weight. Don’t forget, if upgrading to a brushless motor, a “brushless” speed controller such as

the ElectriFly BL-8™ 8-Amp ESC (GPMM2070) **must** be used. This kit also includes the firewall and instructions for mounting a brushless motor.

## Propeller Selection

A 10 x 3.5 propeller is included in this kit, and this propeller offers the best performance with the included brushed motor system. If you are upgrading to the RimFire brushless motor, a 9 x 3.5 propeller is recommended.

## Glue

Though there may be a few different types of adhesives that the FlatOut Reflection ARF could be assembled with, we have had the best success with, and exclusively recommend, foam-safe CA such as 1 oz. Great Planes Foam Safe Thick CA (GPMR3072). Regular CA is not recommended as it will aggressively attack the foam used in this model. In addition to being foam-compatible, foam-safe CA is also suitable for gluing together all of the rest of the materials (balsa, carbon) included in this kit. No other adhesive is required to build the FlatOut Reflection ARF.

## ADDITIONAL ITEMS REQUIRED

### Adhesives & Building Supplies

In addition to common household tools and hobby tools, this is the “short list” of the most important items required to build the FlatOut Reflection ARF. **Great Planes Pro™ CA and Epoxy glue are recommended.**

- Great Planes Aerosol Activator (GPMR6034)
- Hobbico® CA Applicator tips (HCAR3780)
- Hobby knife with #11 blade (HCAR0100)
- #11 Blades (5-pack: HCAR0211)
- 1m Metric ruler (for identifying tubes and rods)
- 5-1/2" [140mm] Easy-Touch™ bar sander (GPMR6169) with 220-grit sandpaper (GPMR6185)
- Drill bits: 1/16" [1.5mm], 3/32" [2.5mm]
- Double-sided foam tape (GPMQ4400)
- Stick-on weight (GPMQ4485)
- 1/2" [13mm]-wide Cellophane tape
- Great Planes Plan Protector™ (GPMR6167) or wax paper

## KIT INSPECTION

Before starting to build, take an inventory of this kit to make sure it is complete, and inspect the parts to make sure they are of acceptable quality. If any parts are missing or are not of acceptable quality, or if you need assistance with assembly, contact **Product Support**. When reporting defective or missing parts, use the part names exactly as they are written in the Kit Contents list.

**Great Planes Product Support:**  
**3002 N. Apollo Drive, Suite 1**  
**Champaign, IL 61822**  
**Telephone: (217) 398-8970, ext. 5**  
**Fax: (217) 398-7721**  
**E-mail: [airsupport@greatplanes.com](mailto:airsupport@greatplanes.com)**

## KIT CONTENTS

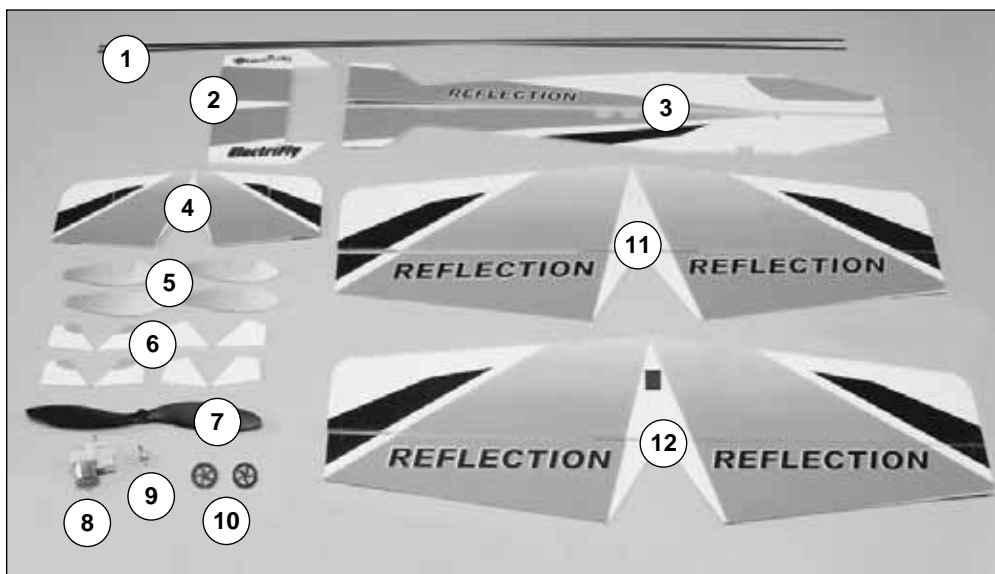

### Kit Contents

1. Carbon Rods & Tubes
2. Rudder
3. Vertical Fuselage Halves (2)
4. Horizontal Stabilizer
5. Wheel Pants
6. Fuselage Nose Doublers
7. Propeller
8. Motor/Gearbox Assembly
9. Prop Saver
10. Main Wheels
11. Top Wing & Ailerons
12. Bottom Wing & Ailerons

### Kit Contents (Not Photographed)

#### Plastic Tree Parts

- A1 Z-Bend Clevis (10)
- A2 Offset Z-Bend Clevis (4)
- B1 Stand-Alone Control Horn (5)
- B2 Stand-Alone Control Horn Retainer (5)
- C1 Clip Hinge Control Horn (5)
- C2 Clip Hinge (26)
- C3 Hinge Retainer Ring (10)
- C4 Aileron Link Horn (4)
- D1 Axle Support (2)
- D2 Rod Support (12)
- D4 Tailwheel Bracket (1)
- D5 Tailwheel (1)
- D6 Wheel Collar (2)
- E1 Control Surface Brace (4)
- E2 Fuselage Joiner (3)
- E3 Pushrod Support (4)
- F1 Wire Clip (4)

- F2 Wing Servo Mount (1)
- F3 Fuselage Servo Mount (2)
- F4 Fuselage Aileron Servo Mount (1)
- G1 Double-Sided Offset Arm, Size B (2)
- G2 Double-Sided Arm, Size B (2)
- G3 Single-Sided Arm, Size B (4)
- G4 Double-Sided Arm, Size A (2)
- G5 Double-Sided Offset Arm, Size A (2)
- G6 Single-Sided Arm, Size A (4)
- G7 Double-Sided Arm, Size C (2)
- G8 Double-Sided Offset Arm, Size C (2)
- G9 Single-Sided Arm, Size C (4)

#### Carbon Rods 7 Tubes

- Fuselage Doubler Tube 5.5 x 248mm
- Elevator Joiner Tube 35 x 192mm
- Rudder Post Tube 3 x 145mm
- Fuselage Main Tube 3 x 665mm

- Leading Edge Tube 3 x 328mm (4)
- Trailing Edge Tube 3 x 700mm (2)
- Landing Gear Legs 2 x 358mm (2)
- Rear Wing Struts 2 x 212mm (2)
- Wheel Axles 2 x 17mm (2)
- Rudder Pushrod 1 x 380mm
- Elevator Pushrod 1 x 320mm
- Aileron Pushrod 1 x 90mm (2)
- Aileron Link Pushrod 1 x 149mm (2)

#### Other Parts

- Firewall
- O-rings
- Interplane Struts (2)

# ORDERING REPLACEMENT PARTS

Replacement parts for the Great Planes FlatOut Reflection ARF are available using the order numbers in the **Replacement Parts List** that follows. The fastest, most economical service can be provided by your hobby dealer or mail-order company.

To locate a hobby dealer, visit the Hobbico web site at [www.hobbico.com](http://www.hobbico.com). Choose "Where to Buy" at the bottom of the menu on the left side of the page. Follow the instructions provided on the page to locate a U.S., Canadian or International dealer. If a hobby shop is not available, replacement parts may also be ordered from Tower Hobbies at [www.towerhobbies.com](http://www.towerhobbies.com), or by calling toll free (800) 637-6050.

Parts may also be ordered directly from Hobby Services by calling (217) 398-0007, or via facsimile at (217) 398-7721, but full retail prices and shipping and handling charges will apply. Illinois and Nevada residents will also be charged sales tax. If ordering via fax, include a Visa® or MasterCard® number and expiration date for payment.

Mail parts orders and payments by personal check to:

Hobby Services  
3002 N. Apollo Drive, Suite 1  
Champaign, IL 61822

Be certain to specify the order number exactly as listed in the **Replacement Parts List**. Payment by credit card or personal check only; no C.O.D.

If additional assistance is required for any reason contact Product Support by e-mail at [productsupport@greatplanes.com](mailto:productsupport@greatplanes.com), or by telephone at (217) 398-8970.

### Replacement Parts List

<u>Order Number</u>	<u>Description</u>	<u>How to Purchase</u>
	Missing pieces .....	Contact Product Support
	Instruction manual .....	Contact Product Support
	Full-size plans .....	Not available
	Kit parts listed below .....	Hobby Supplier
GPMP0217 .....	Gear Drive Body	
GPMG0860 .....	Prop Shaft & Spur Gear	
GPMG0239 .....	Pinion Gear	
GPMG0312 .....	Replacement Motor	
APCQ5016 .....	10 x 3.8" Propeller	
GPMQ4620 .....	Prop Saver	
GPMA2794 .....	Hardware Set	
GPMG0215 .....	Motor/Gear Drive Assembly	
GPMQ4618 .....	Prop Saver O-ring	

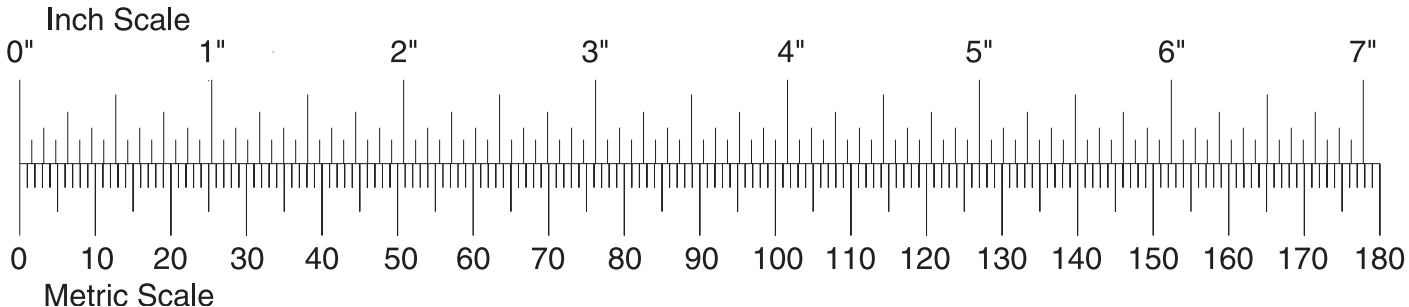

# BUILD THE AIRPLANE

## Assemble the Horizontal Tail

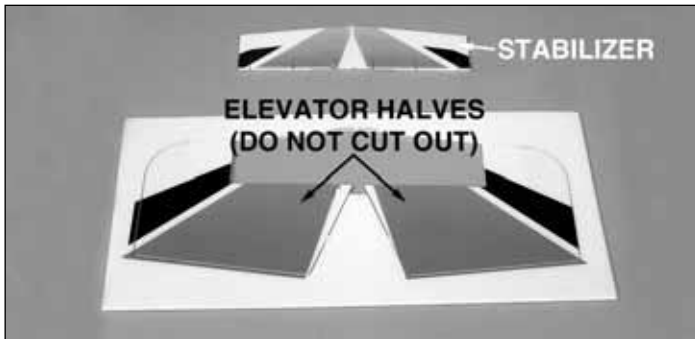

❑ 1. Cut the **stabilizer** free from the foam sheet using a hobby knife with a sharp #11 blade. **DO NOT** cut the **elevator halves** free at this time.

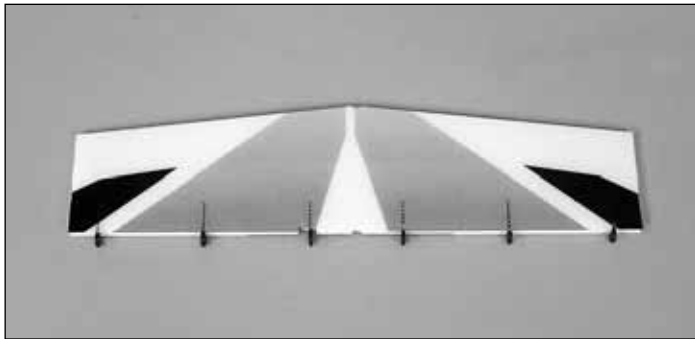

❑ 2. Following the **Expert Tip** below, use foam-safe CA and accelerator to glue six **clip hinges** into the stabilizer, using the 3 x 192mm [1/8" x 7-1/2"] **elevator joiner tube** as a guide.



### HOW TO INSTALL CLIP HINGES

*The clip-hinge system provides a precision, free-moving hinge. Always use this method when instructed to install clip hinges.*

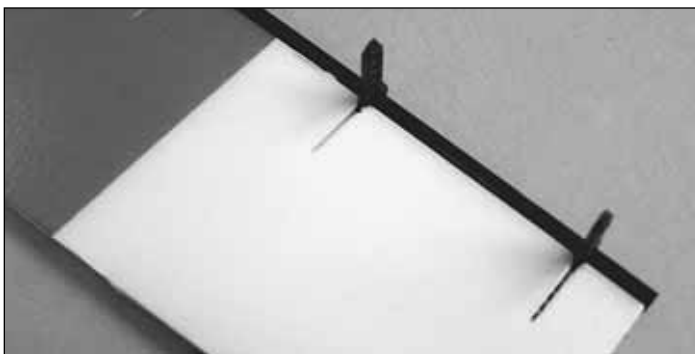

**A.** Snap all of the hinges onto the carbon tube. Align the hinges with the slots.

**B.** Coat both sides of one hinge with foam-safe CA where it contacts the sides of the hinge slot. Rotate the hinge down into the slot. Be certain the top and bottom of the hinge remains flush with the top and bottom of the control surface you are hinging. **IMPORTANT:** Avoid getting any CA on the tube or the arms of the clips. The clips must rotate freely on the tube.

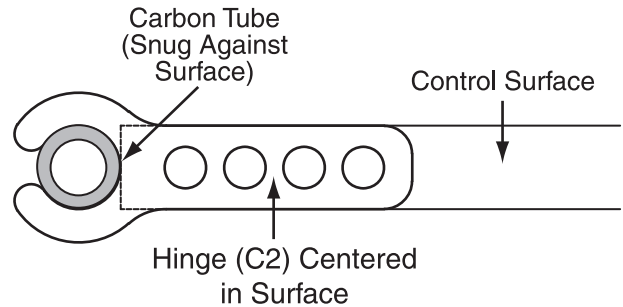

**C.** One at a time, coat the sides of the rest of the hinges and glue them into the slots.

❑ 3. Remove the elevator joiner tube from the hinges.

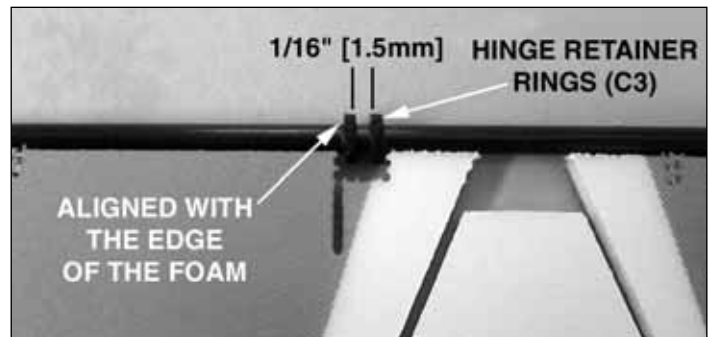

❑ 4. Without removing the elevator halves from the foam sheet, slide two **hinge retainer rings (C3)** onto the elevator joiner tube. Align the rings with the cutout in the right elevator half. There should be a 1/16" [1.5mm] gap between the two rings. Secure both rings to the tube with a drop of glue on the outside of the gap.

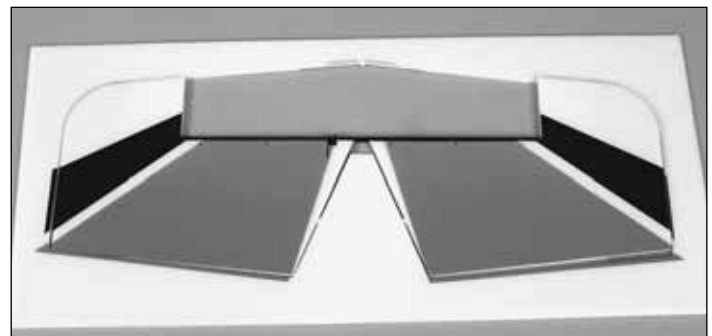

❑ 5. Using the **Expert Tip** that follows, permanently join the elevator halves by gluing in the elevator joiner tube.



### HOW TO GLUE THE TUBES TO THE CONTROL SURFACES

**Note:** You may want to protect your work surface from excess glue. We recommend the use of Great Planes Plan Protector (GPMR6167) for this purpose.

**A.** Cut several 38mm [1-1/2"] pieces of cellophane tape. Fold the last 6mm [1/4"] over to make a tab for easy removal.

**B.** Lightly coat the leading edges of the elevators with foam-safe CA—do not use an excessive amount of. **Hint:** A CA applicator tip is recommended to accurately control the bead of glue.

**C.** Tape the tube to the leading edge of the elevators. Weight the assembly down on a **flat** surface to prevent warping and allow the glue to harden without accelerator.

**D.** Once the glue has hardened, remove the tape.

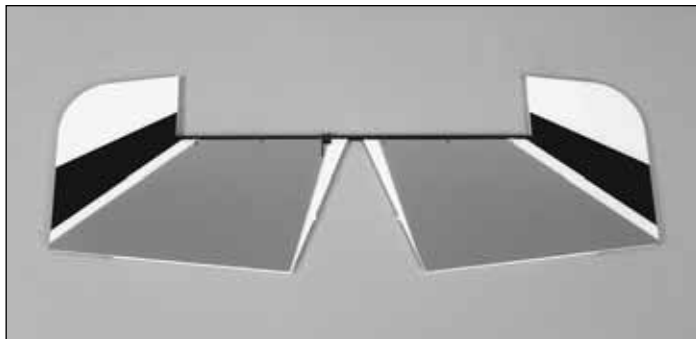

❑ 6. Now the elevator halves may be cut from the sheet

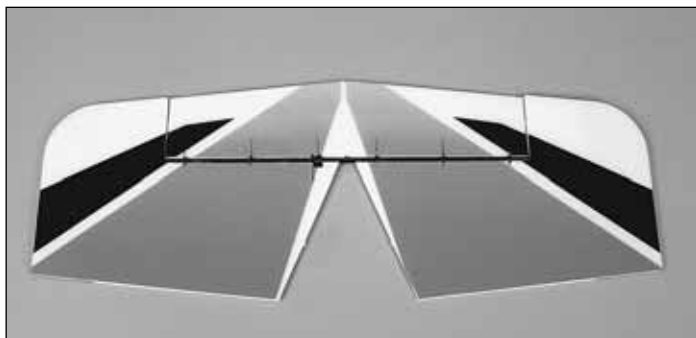

❑ 7. Join the elevators to the stab by snapping the clip hinges to the joiner tube.



❑ 8. Insert a Z-bend clevis (A1) into a clip-hinge control horn (C1).



### HOW TO INSTALL Z-BEND CLEVISES



**A.** Using a sharp #11 hobby knife, remove any flashing from the inside of the hole you are installing the Z-bend clevis into. Do this by rotating the blade in the hole while applying gentle pressure. Be careful not to remove too much material—your goal here is to remove small ridges of flashing, not to make the hole larger.

**B.** Snap the Z-bend clevis into place.

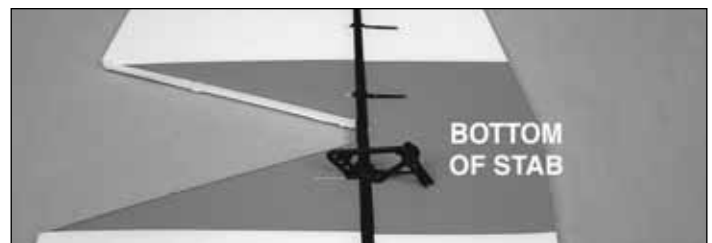

❑ 9. Clip the control horn onto the joiner tube aligned with the precut slot.

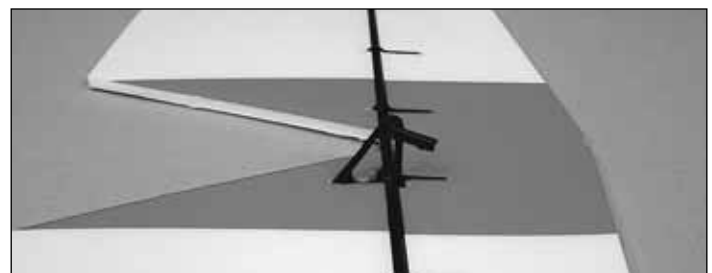

❑ 10. Coat the gluing area on the control horn with glue and rotate it down into the precut slot.

## Assemble the Fuselage

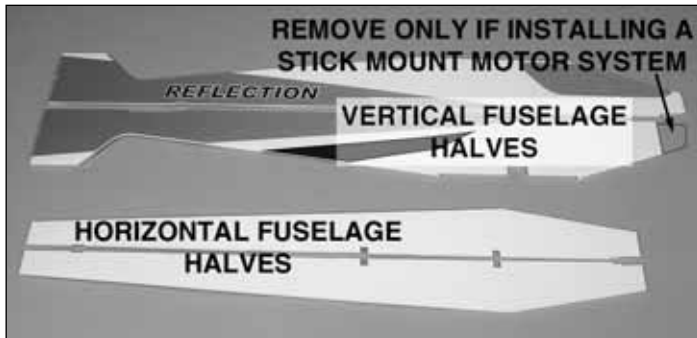

❑ 1. Cut the **upper** and **lower vertical fuselage halves** and the **right** and **left horizontal fuselage halves** free from their foam sheets. If using the gearbox included with this kit, or any other type of “stick-mount” gearbox, cut-out the section shown from the bottom vertical fuselage half.

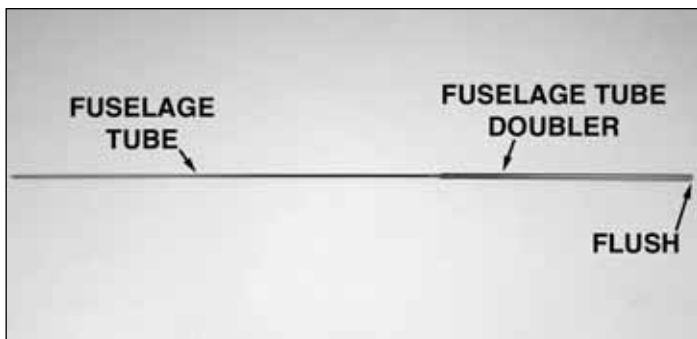

❑ 2. Glue the 5.5 x 248mm [7/32" x 9-3/4"] **fuselage tube doubler** over the 3 x 665mm [1/8" x 26-3/16"] **fuselage tube**. One end should be flush. From now on, this assembly will be referred to as the **fuselage tube**.

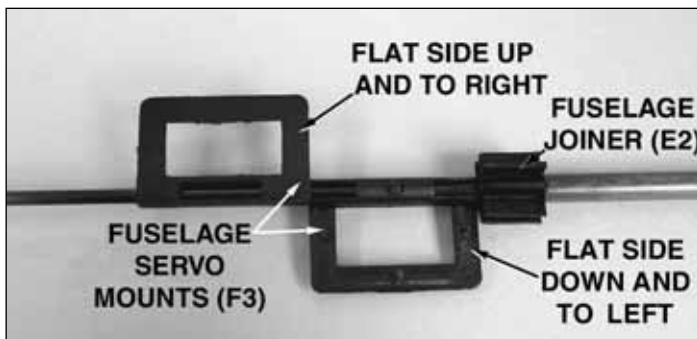
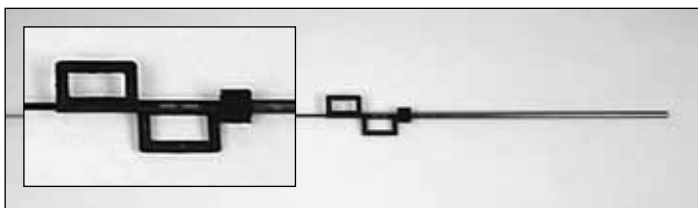

❑ 3. Slide a **fuselage joiner (E2)**, two **fuselage servo mounts (F3)**, and another fuselage joiner onto the fuselage tube. With the tube doubler forward, the front servo mount should hang down with its flat surface on the left, and the rear servo mount should point up with its flat surface on the right.



❑ 4. Position the servo mounts and fuselage joiners so that they align with the precut slots in the upper vertical fuselage half.

❑ 5. Glue the fuselage tube to the upper vertical fuselage half.

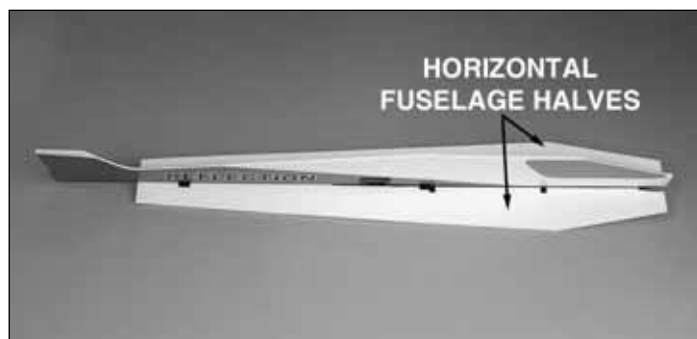

❑ 6. Glue the left and right horizontal fuselage halves to the fuselage tube. Make sure they are perpendicular to the upper vertical fuselage.

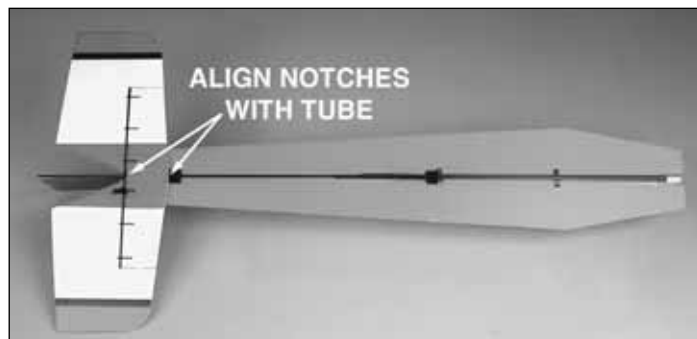

❑ 7. Glue the stabilizer into position with the leading edge of the stab butted against the rear fuselage joiner. Align the notches in the stab with the fuselage tube.



❑ 8. Glue the **lower vertical fuselage** half to the fuselage tube. Make sure to keep it parallel with the upper half and perpendicular to the horizontal fuselage.

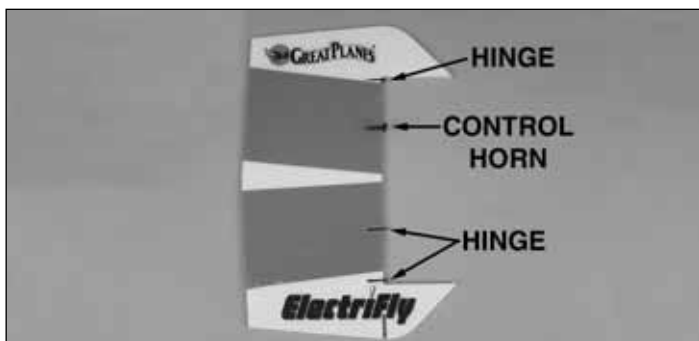

9. Install a Z-bend clevis (A1) into a clip hinge control horn (C1). Using the 3 x 145mm [1/8" x 5-11/16"] **rudder post tube** as a guide, glue three clip hinges and the clip hinge control horn to the **rudder**.



10. Snap the **tailwheel (D4)** into the **tailwheel bracket (D5)** and slide the tailwheel bracket onto the 3 x 20mm [1/8" x 3/4"] tailwheel tube. Glue this assembly into the slot in the rudder.

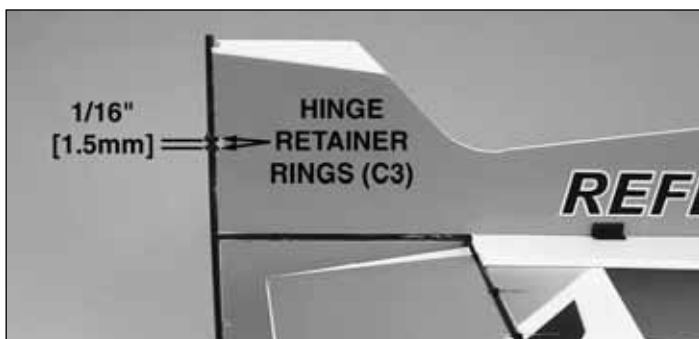

11. Slide two **hinge retainer rings (C3)** onto the top of the rudder post. Align the rings with the slot in the TE of the fuselage. Secure each ring with a drop of glue on the outside. Glue the rudder post tube to the TE of the vertical fuselage.



12. Snap the rudder onto the rudder post.

## Assemble the Wing



1. Cut the wings and all four ailerons free from the foam sheet. Identify the top and bottom wings. The bottom wing has the aileron servo bay.



2. Following the **Expert Tip** previously described, use a 3 x 700mm [1/8" x 27-9/16"] **wing trailing edge tube** as a guide to glue hinges into the slots in two of the ailerons. These will be the top ailerons.



3. Insert **offset Z-bend clevises (A2)** into opposing sides of two clip-hinge stand alone control horns (B1).

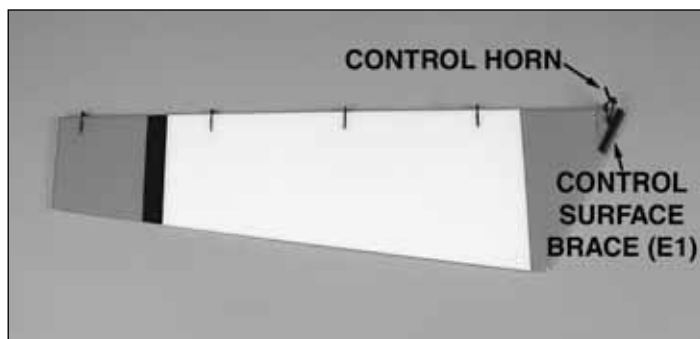

4. Using the **Expert Tip** previously described, use a 3 x 700mm [1/8" x 27.5"] **wing trailing edge tube** as a guide to glue hinges and one control horn each into two of the

ailerons. The control horns should protrude from the bottom of the ailerons (red and white side), and the offset Z-bend clevises should be on the outboard sides of the horns. Glue a **control surface brace (E1)** onto the roots of these two ailerons. Remove the tube once the CA has hardened. These will be the bottom ailerons.

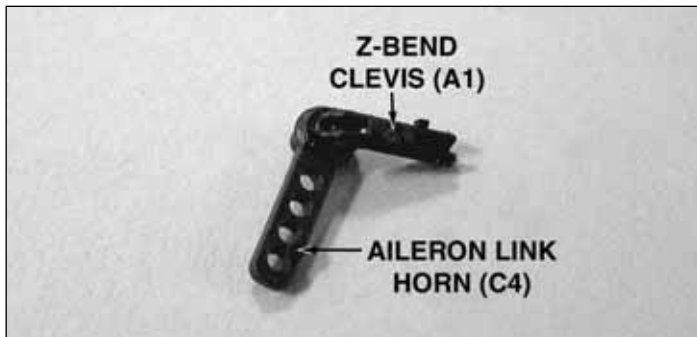

❑ 5. Install a Z-bend clevis (A1) into each of the four **aileron link horns (C4)**.



❑ 6. Glue the aileron link horns into the slots in the TEs of the ailerons. The Z-bend clevises (A2) should be on the outboard side of the ailerons.

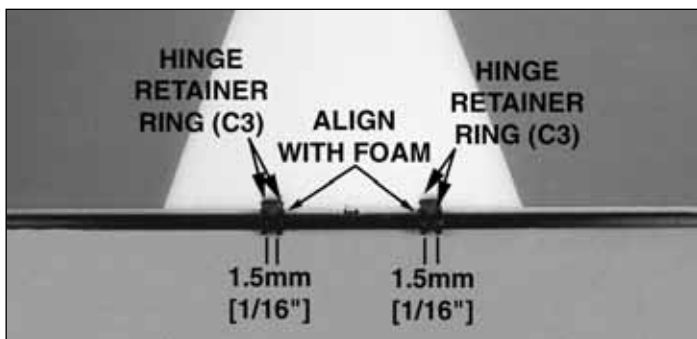

❑ 7. Slide four hinge retainer rings (C3) onto each of the wing trailing edge tubes. Position the rings so that they align with the inner slots in the TE of the wings. Secure each retainer with a drop of glue on the outside of the gap.

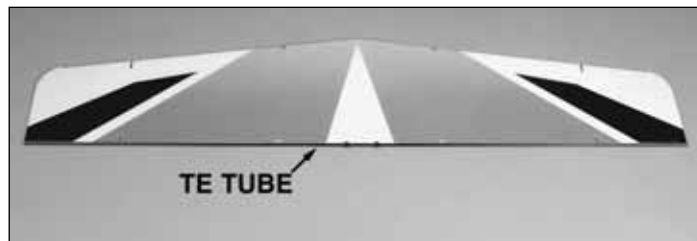

❑ 8. Glue the trailing edge tubes to the TEs of the wings.

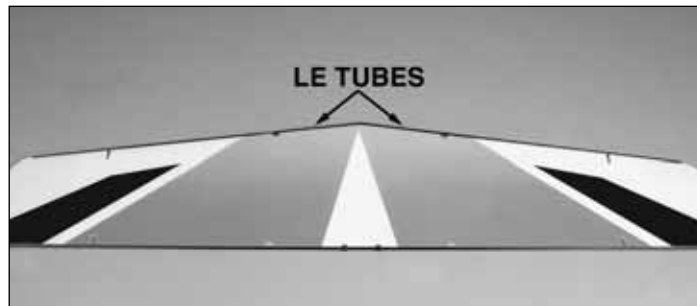

❑ 9. Glue the 3 x 328mm [1/8" x 12-15/16"] **wing leading edge tubes** to the LEs of the wings.

❑ 10. Locate twelve **rod supports (D2)**. In the following steps note six of the supports will be used for the main landing gear and six of the supports will be used for the wing struts at the trailing edge of the wing, but all of the supports are exactly the same.

**IMPORTANT!!!** Before gluing in any of the supports, be certain to read the steps all the way through so you will understand how the supports go in.

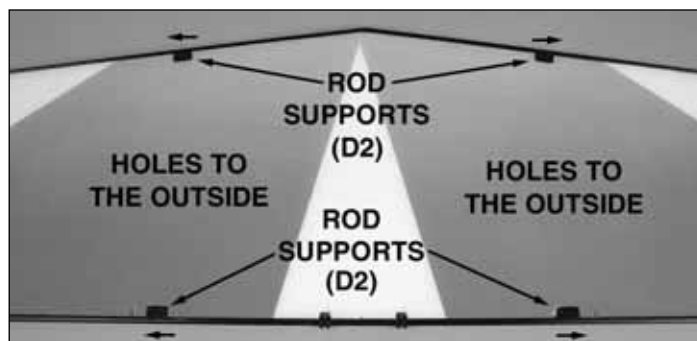
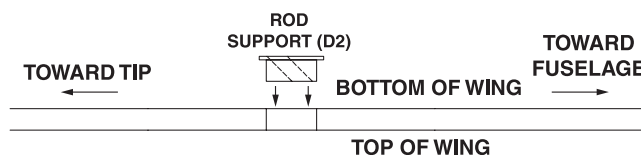

❑ 11. Installing them down through the top of the top wing, glue four supports into the slots in both sides of the top wing. Two of the supports are at the leading edge (for the landing gear) and two are at the trailing edge (for the wing struts). **IMPORTANT:** The holes in the supports must be angled **upward** and **outward** (matching the angle of the landing gear and the wing struts). This means that when viewed from the top, the holes in each of the supports will be toward the tips of the wing.

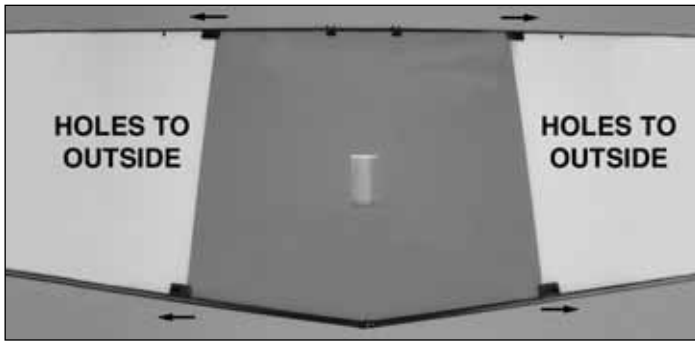

❑ 12. Installing them from the bottom of the bottom wing, glue four supports into the slots in both sides of the top wing. Two of the supports are at the leading edge (for the landing gear) and two are at the trailing edge (for the wing struts). **IMPORTANT:** The holes in the supports must be angled **downward** and **outward** (matching the angle of the landing gear and the wing struts). This means that when viewed from the bottom, the holes in each of the supports will be toward the tips of the wing. The last four supports will be installed in the next section.

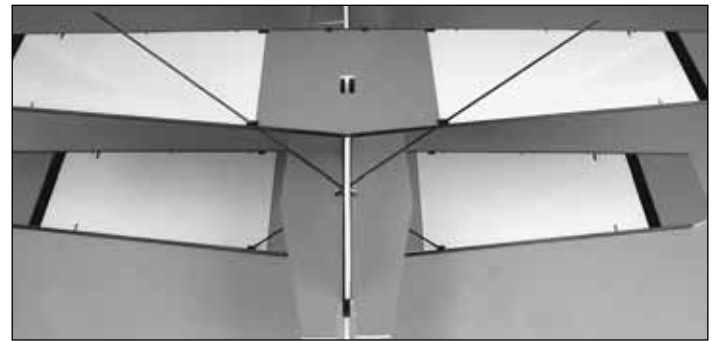

❑ 3. Slide the 2 x 358mm [5/64" x 14-1/16"] **landing gear legs** through the landing gear supports in the front of the wings and fuselage. Ensure that the wings are parallel with the stab and horizontal fuselage and perpendicular to the vertical fuselage. Once satisfied with alignment, secure the landing gear legs with a drop of glue on both sides of each joint.

### Final Assembly



❑ 1. Glue the top and bottom wings to the vertical fuselage. Use the slots in the LE and TE of the wings to align the wings with the fuselage.



❑ 4. Slide the 2 x 212mm [5/64" x 8-5/16"] **wing struts** through both sets of supports in the back of the wing and fuselage. Make sure that the TEs of the wings are aligned with the LEs, and secure the struts with a drop of glue on both sides of each joint.



❑ 2. Installing them from the **left** side, glue two more supports into the slots in the fuselage. Note that and that the holes in the supports should be angled downward and outward (again, to accommodate the angles of the landing gear and the struts). Glue the remaining two supports into the right side of the fuselage. Be certain that the holes are angled correctly.

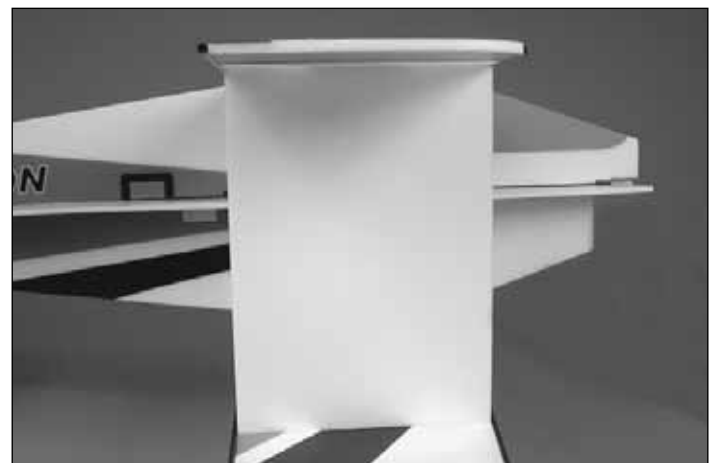

❑ 5. Glue the **interplane struts** between the wings, using the precut slots and tabs for alignment.

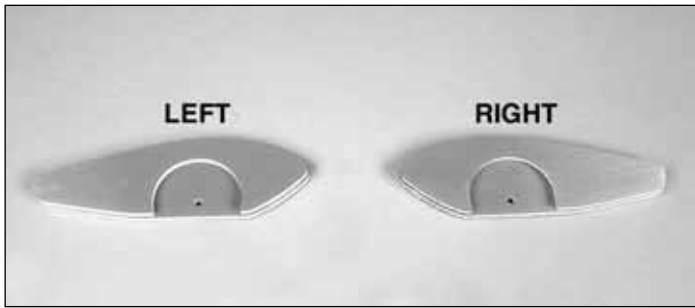

❑ 6. Glue the **inner wheel pants** to the **outer wheel pants**. Make sure to make one left and one right wheel pant.

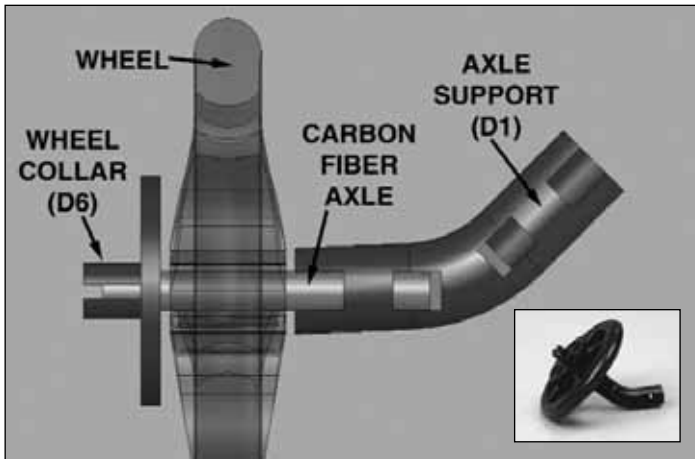

❑ 7. Assemble the **axle supports (D1)**, **axes**, **wheels**, and **wheel collars (D6)** to make two landing gear assemblies. Secure the wheel collar and axle support with a drop of glue.

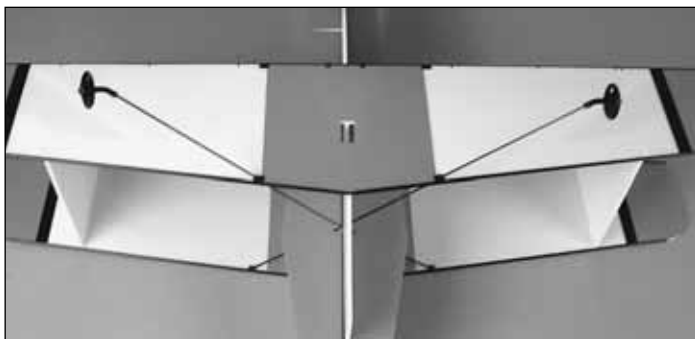

❑ 8. Slide the landing gear assemblies onto the landing gear legs. Align the wheels with the centerline, and secure the axle supports with a drop of glue.

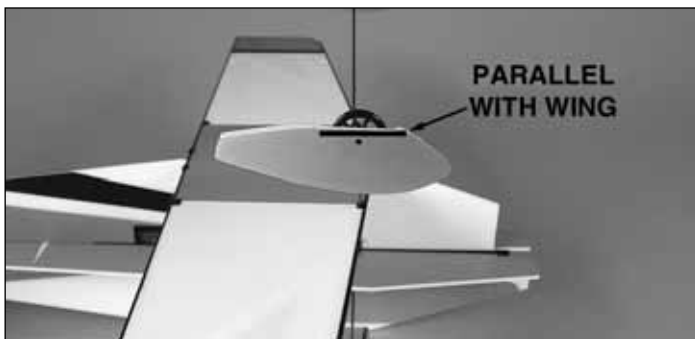

❑ 9. Glue the wheel pants to the wheel collars, keeping the bottom of the wheel pants aligned with the bottom of the wing.



❑ 10. Snap the ailerons onto the wing TE.

### Radio Setup

- ❑ 1. Remove the stock servo arms from all three of the servos.
- ❑ 2. Refer to the parts layout diagram in the front of the manual and select the correct spline size for the servos you will be using. There are three sizes to choose from:

Servo Arm A	Hitec HS-55, Hitec HS-50, Futaba 3108M
Servo Arm B	Futaba S3103, Airtronics 94091
Servo Arm C	JR 241



❑ 3. Glue the rudder servo into the **rear** servo mount in the right side of the fuselage. The output shaft should be forward.



❑ 4. Glue the elevator servo into the **front** servo mount in the left side of the fuselage. The output shaft should be forward.

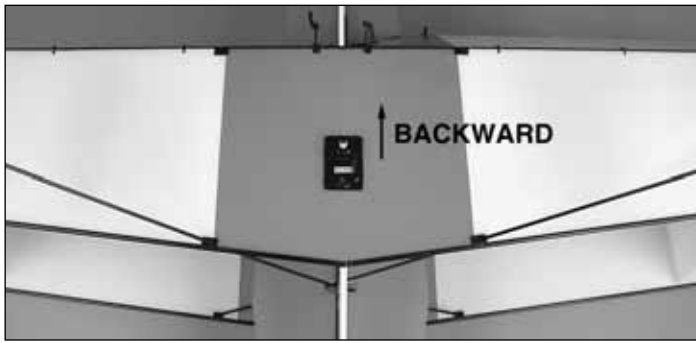

❑ 5. Glue the aileron servo into a **wing servo mount** and glue the assembly into the bottom of the bottom wing with the output shaft toward the rear.

❑ 6. Cut a small hole in the fuselage to allow the elevator servo wire to pass through to the left side of the fuselage. pass the rudder servo wire down through the hole that the rear wing struts pass through. Connect the servos to the receiver and mount the receiver to the fuselage with double-sided foam tape. Power up the radio system and center all three servos.

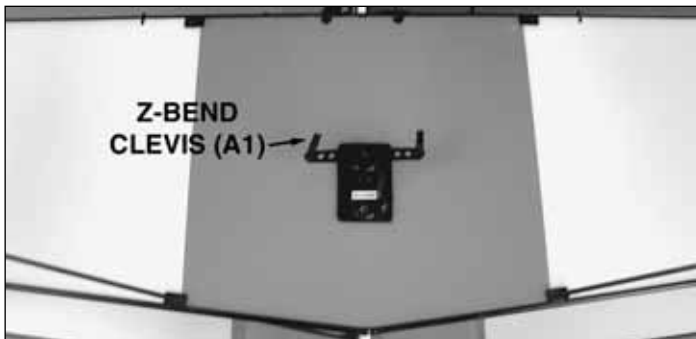

❑ 7. Insert two **Z-bend clevises (A1)** into a **double-sided servo arm** that fits your servo. Install the servo arm on the aileron servo in the position shown.

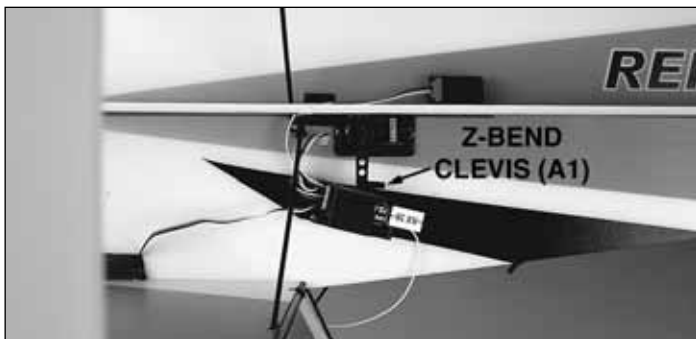

❑ 8. Install a Z-bend clevis (A1) into a **single-sided servo arm** that fits your elevator servo. Install the arm onto the elevator servo so that it is straight down with the servo centered.

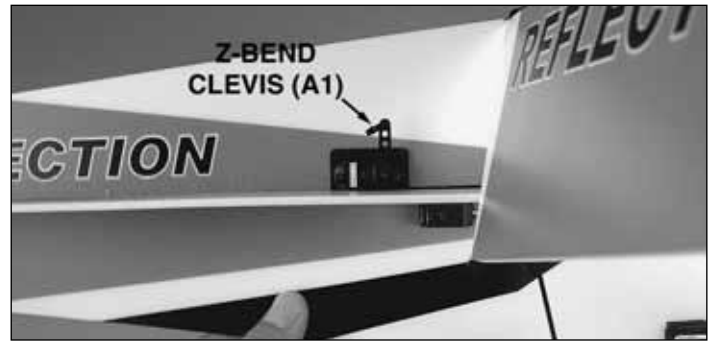

❑ 9. Install a Z-bend clevis (A1) into a single-sided servo arm that fits your rudder servo. Install the arm onto the elevator servo so that it is straight up with the servo centered.

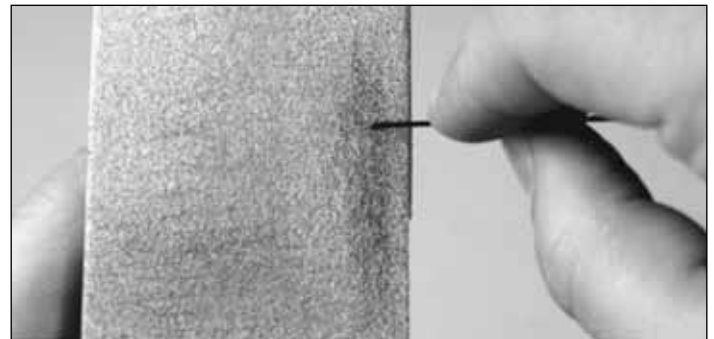

❑ 10. Using an Easy-Touch bar sander with 220-grit sandpaper, sharpen the ends of all the 1mm [3/64"] carbon **pushrods**. This will make them much easier to install through the Z-bend clevises.



❑ 11. Slide two 1 x 90mm [3/64" x 3-1/2"] **aileron pushrods** through the clevises in the aileron horns and servo arms. Adjust the clevises until the ailerons are centered with the servo centered. When you have the alignment correct, secure the pushrods with a drop of glue where the pushrod enters the clevis. Keep glue away from the end of the clevis where it pivots in the arm or horn.



12. Slide a 1 x 149mm [3/64" x 5-7/8"] **aileron link pushrod** into the clevises on each set of aileron link horns. Adjust the clevises until each set of ailerons are parallel. When you have the alignment correct, secure the pushrods with a drop of glue where the pushrod enters the clevis. Keep glue away from the end of the clevis where it pivots in the horn.



15. Install the 1 x 380mm [3/64" x 15"] **rudder pushrod** the same way.



13. Slide two **pushrod supports** onto the **elevator pushrod** 1 x 320mm [3/64" x 12-9/16"] and slide the pushrod through the clevises on the elevator servo arm and control horn. Adjust the clevises until the elevator is centered with the servo centered. Secure the clevises with a drop of glue on each clevis where the pushrod enters it.

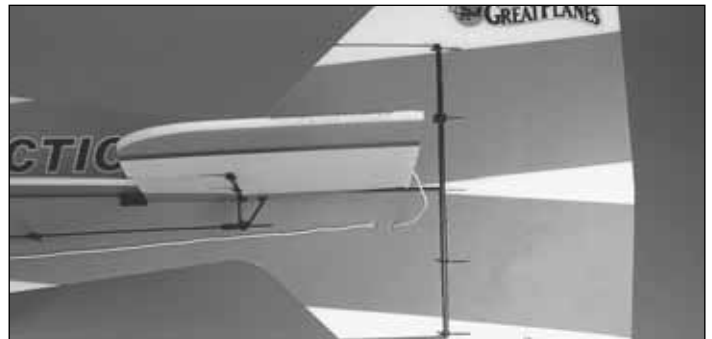

16. Drill two 1.5mm [1/16"] holes through the fuselage where shown. "Stitch" the receiver antenna through these holes.

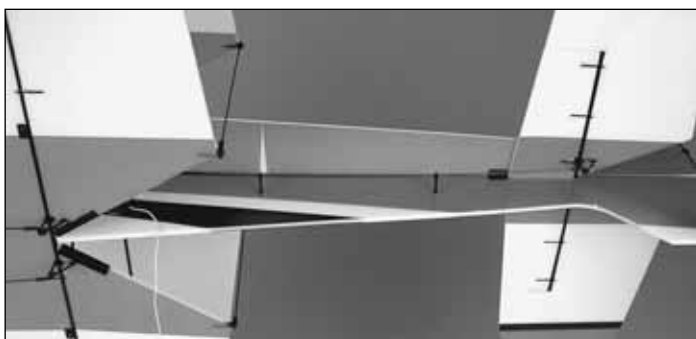

14. Using the pushrod as a guide, drill two evenly-spaced 2.4mm [3/32"] holes through the fuselage for the pushrod guides. Glue the base of each pushrod guide into the holes.

### Mount the Motor & Gearbox

If mounting the included stick-mounted motor and gearbox or an aftermarket geared brushless system, then follow the instructions in this section. If mounting a firewall-mounted motor system, proceed to "**Firewall-Mounted Motor System**" on page 17.

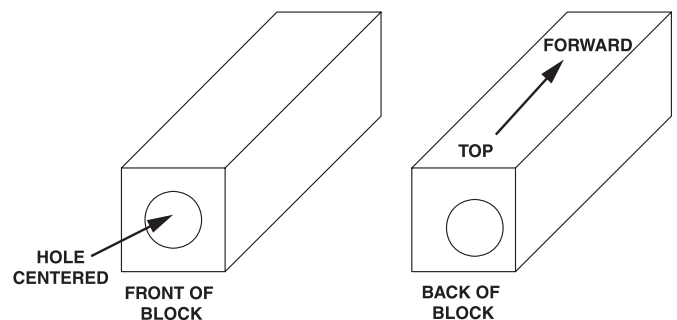

1. The 10 x 10 x 27mm [13/32" x 13/32" x 1-1/16"] hardwood **motor mount block** must be mounted in the correct orientation. Identify the top, aft end of the block as shown in the sketch so you will know how it is to be installed.



❑ 2. Slide the motor mount block over the fuselage tube. Be certain the block is in the correct position so there will be **down** and **right** thrust. Glue the motor mount block onto the fuselage tube.



❑ 3. If using the included propeller, install the **prop saver** onto the gearbox shaft with the large-diameter cone forward. If using a GWS prop, install the prop saver with the small-diameter cone forward. Tighten the screws, making sure they engage the flat spots on the shaft. Slide the **motor/gearbox assembly** over the motor mount block.

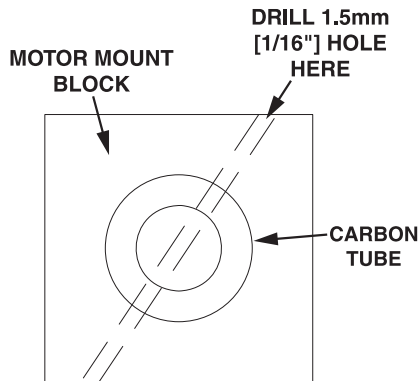

❑ 4. Drill a 1.5mm [1/16"] pilot hole at an angle from the top of the gearbox through the balsa block and carbon tubes. Make sure the motor mount block does not rotate while drilling. Secure the gearbox and block with a 2 x 8mm [3/32" x 5/16"] wood screw.

❑ 5. If using the included prop, insert the larger of the two **adapter rings** (included in the propeller packaging) into the rear of the propeller hub.



❑ 6. Mount the prop to the prop saver with one of the included O-rings.



❑ 7. Connect your speed control to the motor and receiver. Mount the speed control to the bottom of the left horizontal fuselage with double-sided foam tape. Cut small holes for the ESC's battery wire to cross to the top right side of the fuselage.



❑ 8. Install the "hook" side of the included hook-and-loop material to the left side of the fuselage where shown. This is where you will mount the battery.

## Firewall-Mounted Motor System

Use the following instructions if you are installing a firewall-mounted motor system, such as the *ElectriFly RimFire* outrunner.



❑ 1. If you have previously removed the nose section of the bottom vertical fuselage, glue it back into place.



❑ 2. Cut the **nose doublers** from their foam sheets. Glue the doublers for the vertical fuselage into position first, then glue the doublers for the horizontal fuselage into position.



❑ 3. Use a 220-grit bar sander to **lightly** sand the front of the fuselage even. Be careful not to change the built-in thrust angles.

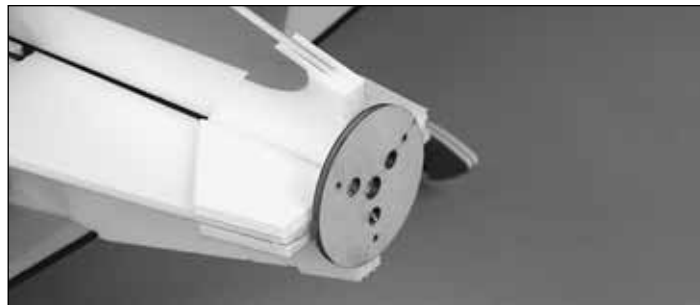

❑ 4. If installing an *ElectriFly RimFire* motor, glue the included 3mm [1/8"] plywood firewall to the nose so that the center hole is centered on the fuselage tube. **Note:** If installing another brand of outrunner motor, you will need to cut your own firewall to match its mount pattern. The motor and firewall should be mounted so that the thrustline is centered on the fuselage tube.



❑ 5. Mount the motor using the hardware and instructions that came with your motor.



❑ 6. Mount the propeller using the hardware and instructions that came with your motor.

❑ 7. Install your ESC as instructed in steps 7-8 of the stick-mount installation section above.

## GET THE MODEL READY TO FLY

### Check the Control Directions



- ❑ 1. Attach the “loop” side of the hook-and-loop material to the battery. Mount the battery to the fuselage.
- ❑ 2. For safety, remove the propeller while performing bench setup. Once you have finished setting up your airplane, you can reinstall it.
- ❑ 3. Lower the throttle stick all the way and turn on the transmitter. Connect your battery to the ESC. If the ESC has a BEC switch, turn it on.
- ❑ 4. Check all the control surfaces to see if they are centered. Since you set the center points as you set up the linkages, they should already be very close. Use the trims on the transmitter to center the controls.

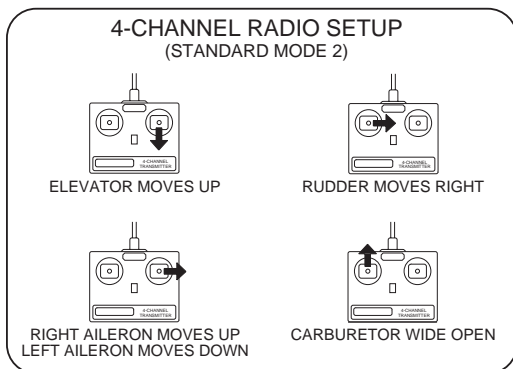

- ❑ 5. Make certain that the control surfaces and the motor respond in the correct direction as shown in the diagram. To operate the motor, you may have to “arm” your ESC. Follow the instructions that came with your ESC to do this. If any of the controls respond in the wrong direction, use the servo reversing in the transmitter to reverse the servos connected to those controls. Be certain the control surfaces have remained centered. Adjust if necessary.

## Set the Control Throws

To simplify setup, the high-rate (3D) control throws for this model are automatically set by the geometry of the included hardware. We do recommend, however, that you perform a quick check as described below to make sure the throws are set up correctly.

**Note:** If your radio has the capability, low-rates will make it easier to perform precision aerobatics. We recommend 40% endpoints for all low-rate throws. If your radio does not have low-rates, setup the plane using only the high-rate throws.

Additionally, you may want to use the exponential function to soften the control response around center. This is largely a matter of personal taste, but helps many pilots balance the extreme throws needed for 3D flying with the need to make small corrections when in normal flight.

We recommend setting up your airplane according to the following table as a *starting point*. Use the **Angle Templates** at the back of the manual to verify that you are in the ballpark. However, setting up models of this type is largely a matter of personal taste. We encourage you to tune the throws to your taste as you get more familiar with the aircraft. Many expert 3D fliers choose to increase their high-rate travel by using higher endpoints.

Function	High-Rate Endpoints	High-Rate Travel	High-Rate Exponential
Aileron	+/- 100%	+/- 55-60°	40%
Elevator	+/- 100%	+/- 55-60°	40%
Rudder	+/- 100%	+/- 55-60°	40%
Function	Low-Rate Endpoints	Low-Rate Travel	Low-Rate Exponential
Aileron	+/- 40%	+/- 15-25°	0%
Elevator	+/- 40%	+/- 15-25°	0%
Rudder	+/- 40%	+/- 15-25°	0%

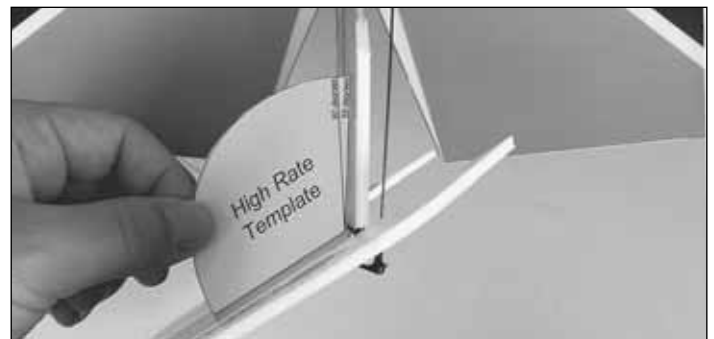

If you are not able to achieve these control throws, double-check your pushrod hookup and make sure any control surfaces in question are operating smoothly. If you have a computer radio also make sure your endpoint adjustments are properly set.

## Balance the Model (C.G.)

More than any other factor, the **C.G.** (balance point) can have the **greatest** effect on how a model flies, and may determine whether or not your first flight will be successful. If you value this model and wish to enjoy it for many flights, **DO NOT OVERLOOK THIS IMPORTANT PROCEDURE.** A model that is not properly balanced will be unstable and possibly unflyable.

At this stage the model should be in ready-to-fly condition with all of the systems in place including the motor, the propeller, the battery, and the radio system.



❑ 1. Use a felt-tip pen or 3mm [1/8"]-wide tape to accurately mark the C.G. on the bottom of the top wing on both sides of the fuselage. The C.G. is located 70mm [2-3/4"] back from the leading edge of the wing at the fuselage.

This is where your model should balance for the first flights. Later, you may wish to experiment by shifting the C.G. up to 13mm [1/2"] forward or 13mm [1/2"] back to change the flying characteristics. Moving the C.G. forward may improve the smoothness and stability, but the model may then require more speed for takeoff and make it more difficult to slow for landing or 3D aerobatics. Moving the C.G. aft makes the model more maneuverable, but could also cause it to become too difficult to control. In any case, **start at the recommended balance point.** As with the throws, though, we encourage you to experiment with the CG until the model flies to your taste.

❑ 2. With all parts of the model installed, including the battery (ready to fly) lift it right side up on your fingertips at the balance point you marked.

❑ 3. If the tail drops, the model is "tail heavy" and the battery pack and/or receiver must be shifted forward or weight must be added to the nose to balance. If the nose drops, the model is "nose heavy" and the battery pack and/or receiver must be shifted aft or weight must be added to the tail to balance. If possible, relocate the battery pack on the hook-and-loop strip to minimize or eliminate any additional ballast required. If additional weight is required, begin by placing incrementally increasing amounts of weight on the bottom of the fuse until the model balances. Once

you have determined the amount of weight required, it can be permanently attached.

❑ 4. **IMPORTANT:** If you found it necessary to add any weight, recheck the C.G. after the weight has been installed.

## Balance the Model Laterally

❑ 1. With the wing level, lift the model by the engine propeller shaft and the bottom of the fuse under the TE of the fin. Do this several times.

❑ 2. If one wing always drops when you lift the model, it means that side is heavy. Balance the airplane by adding weight to the other wing tip. **An airplane that has been laterally balanced will track better in loops and other maneuvers.**

## PREFLIGHT

### Identify Your Model

No matter if you fly at an AMA sanctioned R/C club site or if you fly somewhere on your own, you should always have your name, address, telephone number and AMA number on your model. It is **required** at all AMA R/C club flying sites and AMA sanctioned flying events. Write this information on the bottom of the wing with a fine felt-tip pen.

### Charge the Batteries

Follow the battery charging instructions that came with your radio control system to charge the batteries. You should always charge your transmitter batteries the night before you go flying, and at other times as recommended by the radio manufacturer.

*Charge the flight battery using a charger designed for Lithium-Polymer batteries. Charging with any other type of charger is very dangerous, and may cause the batteries to combust violently.*

**CAUTION:** Unless the instructions that came with your radio system state differently, the **initial** charge on **new** transmitter batteries should be done for 15 hours **using the slow-charger that came with the radio system.** This will "condition" the batteries so that the next charge may be done using the fast-charger of your choice. If the initial charge is done with a fast-charger the batteries may not reach their full capacity and you may be flying with batteries that are only partially charged.

## Range Check

Ground check the operational range of your radio before the first flight of the day. With the transmitter antenna collapsed and the receiver and transmitter on, you should be able to walk at least 50 feet away from the model and still have control. Have an assistant stand by your model and, while you work the controls, tell you what the control surfaces are doing. Repeat this test **with the motor running** at various speeds with an assistant holding the model, using hand signals to show you what is happening. If the control surfaces do not respond correctly, **do not fly!** Find and correct the problem first. Look for loose servo connections or broken wires, corroded wires on old servo connectors, poor solder joints in your battery pack or a defective cell, or a damaged receiver crystal from a previous crash.

## MOTOR SAFETY PRECAUTIONS

**Failure to follow these safety precautions may result in severe injury to yourself and others.**

Keep your face and body as well as all spectators away from the plane of rotation of the propeller whenever the battery is connected.

Keep these items away from the prop: loose clothing, shirt sleeves, ties, scarfs, long hair or loose objects such as pencils or screwdrivers that may fall out of shirt or jacket pockets into the prop.

## AMA SAFETY CODE (excerpts)

Read and abide by the following excerpts from the Academy of Model Aeronautics Safety Code. For the complete Safety Code refer to *Model Aviation* magazine, the AMA web site or the Code that came with your AMA license.

### GENERAL

1) I will not fly my model aircraft in sanctioned events, air shows, or model flying demonstrations until it has been proven to be airworthy by having been previously, successfully flight tested.

2) I will not fly my model aircraft higher than approximately 400 feet within 3 miles of an airport without notifying the airport operator. I will give right-of-way and avoid flying in the proximity of full-scale aircraft. Where necessary, an observer shall be utilized to supervise flying to avoid having models fly in the proximity of full-scale aircraft.

3) Where established, I will abide by the safety rules for the flying site I use, and I will not willfully and deliberately fly my models in a careless, reckless and/or dangerous manner.

5) I will not fly my model unless it is identified with my name and address or AMA number, on or in the model. **Note:** This does not apply to models while being flown indoors.

7) I will not operate models with pyrotechnics (any device that explodes, burns, or propels a projectile of any kind).

### RADIO CONTROL

1) I will have completed a successful radio equipment ground check before the first flight of a new or repaired model.

2) I will not fly my model aircraft in the presence of spectators until I become a qualified flier, unless assisted by an experienced helper.

3) At all flying sites a straight or curved line(s) must be established in front of which all flying takes place with the other side for spectators. Only personnel involved with flying the aircraft are allowed at or in the front of the flight line. Intentional flying behind the flight line is prohibited.

4) I will operate my model using only radio control frequencies currently allowed by the Federal Communications Commission.

5) **I will not knowingly operate my model within three miles of any pre-existing flying site except in accordance with the frequency sharing agreement listed** [in the complete AMA Safety Code].

9) Under no circumstances may a pilot or other person touch a powered model in flight; **nor should any part of the model other than the landing gear, intentionally touch the ground, except while landing.**

## CHECK LIST

During the last few moments of preparation your mind may be elsewhere anticipating the excitement of the first flight. Because of this, you may be more likely to overlook certain checks and procedures that should be performed before the model is flown. To help avoid this, a check list is provided to make sure these important areas are not overlooked. Many are covered in the instruction manual, so where appropriate, refer to the manual for complete instructions. Be sure to check the items off as they are completed.

- 1. Check the C.G. according to the measurements provided in the manual.
- 2. Be certain the battery and receiver are securely mounted on the fuse.
- 3. Extend your receiver antenna and make sure it cannot get tangled in the prop.
- 4. Balance your model *laterally* as explained in the instructions.
- 5. Make sure all hinges are **securely** glued in place.
- 6. Confirm that all controls operate in the correct direction and the throws are set up according to the manual.

- 7. Make sure any servo wiring does not interfere with other systems (servo arms, pushrods, etc.).
- 8. Place your name, address, AMA number and telephone number on your model.
- 9. If you wish to photograph your model, do so before your first flight.
- 10. Range check your radio when you get to the flying site.

## FLYING

The FlatOut Reflection ARF is a great-flying model that flies smoothly and predictably. The FlatOut Reflection ARF does not, however, possess the self-recovery characteristics of a primary R/C trainer and should be flown only by experienced R/C pilots.

### Hand Launch

For the first flight, it is a good idea to have an assistant launch the airplane for you. This allows you to keep your hands on the controls and immediately correct any trim problems that are present.

Have your friend hold the FlatOut Reflection ARF by the canopy. Throttle up to full power, and give the plane a gentle, underhanded toss at about a 30° angle upward. Since the FlatOut Reflection ARF has a very high thrust-to-weight ratio, the plane will accelerate to flying speed almost instantly. Climb to a comfortable height and throttle back to a lower power setting. This plane flies great at about half-throttle when in standard forward flight.

### Rise-Off-Ground (ROG) Takeoffs

Once you have the model trimmed out, the FlatOut Reflection ARF is very capable of ROG (rise-off-ground) takeoffs from a smooth surface (parking lot, runway, gym floor, etc.). To take off, start by advancing the throttle to about two-thirds, making sure to correct any torque reactions with rudder. The plane will build flying speed almost instantly due to its high thrust-to-weight ratio. Once the tail comes up, gently apply up elevator to break ground and climb out. Full throttle takeoffs are necessary only for extremely short runways.

### Flight

When flying a 3D aerobat like the FlatOut Reflection ARF, there are several things you should always keep in mind. First is throttle management—this airplane has enough power to climb straight up at full throttle, so level flight is more comfortably achieved at about half-throttle. Avoid extremely high-speed flight with the FlatOut Reflection ARF—it is designed for slow 3D aerobatics, and extended full-throttle dives can result in wing flutter. While flutter won't

destroy the airplane, it's best to avoid it. Second, take it easy on the control sticks—with 3D throws, even a small stick deflection can result in a big response, so be gentle (unless of course you're performing an aggressive maneuver).

## Landing

Because this model is extremely lightweight, it slows rapidly without power, and performing standard gliding landings can be difficult. Instead, land the model under power, with a rolling 3-point landing as the goal. To achieve this, perform your landing approach with the model in the 3-point attitude (nose up at such an angle that all three wheels are level). Modulate your descent with the throttle, and use a quick "blip" of power just before touchdown to slow the descent for a gentle landing.

***Have a ball! But always stay in control and fly in a safe manner.***

**GOOD LUCK AND GREAT FLYING!**

## OTHER ITEMS AVAILABLE FROM GREAT PLANES



### **ElectriFly RimFire™ 22M-1000 Brushless Outrunner Motor**

Perfect for small, high performance planes such as FlatOuts and smaller 3D aerobats, the RimFire has an exceptionally high power-to-weight ratio and an efficiency rating of up to 77%! Its "outrunner" design eliminates the need for an external gear drive, for easier installation and less weight. Simply attach the prop to the motor with a rubber O-ring (no prop adapter required)...the prop will simply "pop" off in a crash. **GPMG4500**



### ElectriFly 350mAh Li-Po Battery

Ounce for ounce, Lithium-Polymer (Li-Po) cells offer more power than either NiCd or NiMH cells, at less weight. And because they're high-discharge cells, they're great for electric flight and other high-drain applications. Innovative SafeCharge circuitry monitors and limits charge voltage, protecting cells and packs from overcharging. This 350mAh, 11.1V, 3-series pack includes leads, plus a standard 2-pin red connector for charging and a separate 2-pin white connector for discharging. **GPMP0801**



### ElectriFly C-10 Micro Ultra High Frequency Electronic Speed Control

Its solid-state design enables the ElectriFly C-10 Micro to offer a wide array of flight benefits in an incredibly compact, ultralight package. Intended for loads of up to 12A and motors up to 400-size, it features fully proportional forward, brake, plus the throttle smoothness and extended run time of high-frequency operation. Factory-installed radio and battery connectors ease installation. A Safe-Start feature prevents unintentional motor starts. Low voltage cut-off reserves power for safe landing. Built-in BEC eliminates unnecessary weight. 180-day warranty. **GPMM2010**



### Hobbico 12V Power Supply

The 12V Power Supply transforms 110V AC current into constant 13.8V, 11.5A DC power for peak chargers, motor break-in and more. It includes fuse protection, 5V tap, a lighted on/off switch and one-year warranty protection. **HCAP0250**



### ElectriFly™ by Great Planes Triton Peak Charger

Imagine a charger so versatile it can be used with lithium-ion and lead-acid batteries as effectively as NiCd and NiMH cells. A unit that can peak charge tiny park flyer packs and 24V car batteries alike. A charger that can discharge as well as charge, cycle packs from 1 to 10 times automatically, memorize peak and average battery voltages for each cycle - and constantly display battery capacity, voltage, current and time as each cycle progresses. Then, imagine that the charger, which can do all this, is about the size of a thick paperback book, and weighs just over a pound. The advanced computer technology in the Triton Peak Charger makes it possible to accomplish all this and more, through controls and menus so simple that programming is a breeze. For more information, log on at [www.electrifly.com](http://www.electrifly.com) - and be amazed. 1-year warranty. **GPMM3150**



### Hobbico Pro Series™ Quick Field Charger MkII

The MkII is two completely independent chargers in a single case! Current on both sides adjusts from 0.2-2A, to fast charge 1-3 cell Li-Ion or Li-Po park flyer batteries or peak charge 1-8 cell NiCd or NiMH radio packs. Auto-trickle for NiCds and NiMH packs is automatically set, based on the fast-charge rate. Hook up the pack, press the start button - and twin LEDs signal the cell type and charge method to be used by color: red for NiCd, yellow for NiMH and green for Li-Ion or Li-Po cells. Jacks make it easy to hook up your pack - and a voltmeter - to either side. **HCAP0290**

# ANGLE TEMPLATES

