

# Cosmic Wind



**ElectriFLY**<sup>™</sup>  
by Great Planes

## INSTRUCTION MANUAL

### SPECIFICATIONS

<b>Wingspan:</b> 35.75 in [908mm]	<b>Length:</b> 32 in [813mm]	<b>Motor:</b> RimFire <sup>™</sup> .10
<b>Wing Area:</b> 254 in <sup>2</sup> [16.4 dm <sup>2</sup> ]	<b>Weight:</b> 27.5 – 29.5 oz [779–836 g]	
<b>Wing Loading:</b> 15.5–16.5 oz/ft <sup>2</sup> [47–50 g/dm <sup>2</sup> ]	<b>Radio:</b> 4-channel radio	

### WARRANTY

Great Planes<sup>®</sup> Model Manufacturing Co. guarantees this kit to be free from defects in both material and workmanship at the date of purchase. This warranty does not cover any component parts damaged by use or modification. **In no case shall Great Planes' liability exceed the original cost of the purchased kit.** Further, Great Planes reserves the right to change or modify this warranty without notice.

In that Great Planes has no control over the final assembly or material used for final assembly, no liability shall be assumed nor accepted for any damage resulting from the use by the user of the final user-assembled product. By the act of using the user-assembled product, the user accepts all resulting liability.

**If the buyer is not prepared to accept the liability associated with the use of this product, the buyer is advised to return**

**this kit immediately in new and unused condition to the place of purchase.**

To make a warranty claim send the defective part or item to Hobby Services at the address below:

**Hobby Services**  
3002 N. Apollo Dr. Suite 1  
Champaign IL 61822 USA

Include a letter stating your name, return shipping address, as much contact information as possible (daytime telephone number, fax number, e-mail address), a detailed description of the problem and a photocopy of the purchase receipt. Upon receipt of the package the problem will be evaluated as quickly as possible.

READ THROUGH THIS MANUAL BEFORE STARTING CONSTRUCTION. IT CONTAINS IMPORTANT INSTRUCTIONS AND WARNINGS CONCERNING THE ASSEMBLY AND USE OF THIS MODEL.



Champaign, Illinois  
(217) 398-8970, Ext 5  
airsupport@greatplanes.com

# TABLE OF CONTENTS

<b>INTRODUCTION</b> . . . . .	2	Install the Elevator Servo . . . . .	10
Academy of Model Aeronautics . . . . .	2	Install the Rudder Servo . . . . .	12
<b>SAFETY PRECAUTIONS</b> . . . . .	2	Install the Aileron Servo . . . . .	12
<b>DECISIONS YOU MUST MAKE</b> . . . . .	3	<b>FINISH THE MODEL</b> . . . . .	13
Radio Equipment . . . . .	3	Install the Battery Strap . . . . .	13
Servos . . . . .	3	Install the Canopy . . . . .	13
Connectors . . . . .	3	Apply the Decals . . . . .	14
Motor Recommendation . . . . .	3	<b>GET THE MODEL READY TO FLY</b> . . . . .	14
Propeller . . . . .	3	Check the Control Directions . . . . .	14
Electronic Speed Control . . . . .	3	Set the Control Throws . . . . .	14
Flight Battery & Recommended Charger . . . . .	3	Install the Propeller . . . . .	15
<b>ADDITIONAL ITEMS REQUIRED</b> . . . . .	4	Balance the Model (C.G.) . . . . .	15
Required Adhesives and Building Supplies . . . . .	4	Balance the Model Laterally . . . . .	16
Optional Supplies and Tools . . . . .	4	<b>PREFLIGHT</b> . . . . .	16
<b>IMPORTANT BUILDING NOTES</b> . . . . .	4	Identify Your Model . . . . .	16
<b>KIT INSPECTION</b> . . . . .	4	Charge the Batteries . . . . .	16
<b>ORDERING REPLACEMENT PARTS</b> . . . . .	5	Balance Propellers . . . . .	16
<b>KIT CONTENTS</b> . . . . .	5	Range Check . . . . .	16
<b>PREPARATIONS</b> . . . . .	6	<b>MOTOR SAFETY PRECAUTIONS</b> . . . . .	17
<b>ASSEMBLE THE WINGS</b> . . . . .	6	<b>AMA SAFETY CODE</b> . . . . .	17
Join the Wing Halves . . . . .	6	General . . . . .	17
<b>ASSEMBLE THE FUSELAGE</b> . . . . .	7	Radio Control . . . . .	17
Install the Main Landing Gear . . . . .	7	<b>CHECK LIST</b> . . . . .	17
Install the Stabilizer . . . . .	7	<b>FLYING</b> . . . . .	18
Install the Elevators and Rudder . . . . .	9	Takeoff . . . . .	18
Install the Motor . . . . .	9	Flight . . . . .	18
<b>INSTALL THE RADIO SYSTEM</b> . . . . .	10	Landing . . . . .	18

## INTRODUCTION

In 1946 a group of Lockheed employees, including Tony LeVier, designed and built three Cosmic Winds. These very small, single seat racers were designed to compete in the 1947 Goodyear Trophy Race, in Cleveland Ohio. They came in 3rd and 4th in the Race. However, in 1964 one of the three planes called the Ballerina did win the Kings Cup Race in the UK. One of the three original planes is now in the EAA AirVenture Museum in Oshkosh, Wisconsin. Great Planes has taken the great looks of the full scale Cosmic Wind and reduced it down to a light weight, electric powered ARF. The plane is small enough that it can be placed in the back seat of most cars but large and quick enough to still enjoy flying at the local flying field. So if you are ready to fly a piece of racing history, let's get started building.

For the latest technical updates or manual corrections to the "Cosmic Wind EP" visit the Great Planes web site at [www.greatplanes.com](http://www.greatplanes.com). Open the "Airplanes" link, then select the "Cosmic Wind EP" ARF. If there is new technical information or changes to this model a "tech notice" box will appear in the upper left corner of the page.

### Academy of Model Aeronautics

We urge you to join the AMA (Academy of Model Aeronautics) and a local R/C club. The AMA is the governing body of model aviation and membership is required to fly at AMA clubs. Though joining the AMA provides many benefits, one of the primary reasons to join is liability protection. Coverage is not

limited to flying at contests or on the club field. It even applies to flying at public demonstrations and air shows. Failure to comply with the Safety Code (excerpts printed in the back of the manual) may endanger insurance coverage. Additionally, training programs and instructors are available at AMA club sites to help you get started the right way. There are over 2,500 AMA chartered clubs across the country. Contact the AMA at the address or toll-free phone number below:

#### Academy of Model Aeronautics

5151 East Memorial Drive  
Muncie, IN 47302-9252

Tele. (800) 435-9262  
Fax (765) 741-0057



Or via the Internet at: <http://www.modelaircraft.org>

**IMPORTANT!!!** Two of the most important things you can do to preserve the radio controlled aircraft hobby are to avoid flying near full-scale aircraft and avoid flying near or over groups of people.

## SAFETY PRECAUTIONS

**PROTECT YOUR MODEL, YOURSELF & OTHERS...  
FOLLOW THESE IMPORTANT SAFETY PRECAUTIONS**

1. Your "Cosmic Wind EP" should not be considered a toy, but rather a sophisticated, working model that functions very much like a full-size airplane. Because of its performance capabilities, the "Cosmic Wind EP", if not assembled and operated correctly, could possibly cause injury to yourself or spectators and damage to property.

2. You must assemble the model **according to the instructions**. Do not alter or modify the model, as doing so may result in an unsafe or unflyable model. In a few cases the instructions may differ slightly from the photos. In those instances the written instructions should be considered as correct.
3. You must take time to **build straight, true and strong**.
4. You must use an R/C radio system that is in first-class condition, and a correctly sized motor and components throughout the building process.
5. You must correctly install all R/C and other components so that the model operates correctly on the ground and in the air.
6. You must check the operation of the model before **every** flight to insure that all equipment is operating and that the model has remained structurally sound. Be sure to check clevises or other connectors often and replace them if they show any signs of wear or fatigue.
7. If you are not an experienced pilot or have not flown this type of model before, we recommend that you get the assistance of an experienced pilot in your R/C club for your first flights. If you're not a member of a club, your local hobby shop has information about clubs in your area whose membership includes experienced pilots.
8. **WARNING:** The fuselage and wheel pants included in this kit are made of fiberglass, the fibers of which may cause eye, skin and respiratory tract irritation. Never blow into a part (wheel pant) to remove fiberglass dust, as the dust will blow back into your eyes. Always wear safety goggles, a particle mask and rubber gloves when grinding, drilling and sanding fiberglass parts. Vacuum the parts and the work area thoroughly after working with fiberglass parts.

We, as the kit manufacturer, provide you with a top quality, thoroughly tested kit and instructions, but ultimately the quality and flyability of your finished model depends on how you build it; therefore, we cannot in any way guarantee the performance of your completed model, and no representations are expressed or implied as to the performance or safety of your completed model.

**Remember: Take your time and follow the instructions to end up with a well-built model that is straight and true.**

## DECISIONS YOU MUST MAKE

This is a partial list of items required to finish the "Cosmic Wind EP" that may require planning or decision making before starting to build.

### Radio Equipment

A 4-channel radio system with four micro servos and receiver are required for this plane. The servos and receiver shown in the manual are Futaba® S3114 Micro High Torque Servo and the Futaba R617FS receiver.

**Transmitter**  
4-channel

**Receiver**  
7-channel [FUTL7627]

### Servos

- (3) Futaba S3114 Micro High Torque Servos [FUTM0414] [21 oz-in (1.5kg-cm) of torque]

### Connectors

- (1) 9" extensions [FUTM3910]

### Motor Recommendations

The Cosmic Wind ARF comes with a mounting plate for the ElectriFly® RimFire brushless outrunner motor. The motor has been tested with this plane and works well.

- ElectriFly RimFire .10 Brushless Outrunner Motor [GPMG4595]

### Propeller

If using the recommended RimFire Brushless Outrunner Motor, we recommend the APC 8x8E electric propeller [APCQ4116] for good speed performance. For better vertical performance, with a slight reduction in speed, use the APC 9x7.5E [APCQ4119].

### Electronic Speed Control

A brushless ESC (electronic speed control) is required for the recommended motor set-up. We recommend using the ElectriFly Silver Series SS-35A Brushless ESC [GPMM1830].

### Flight Battery

The Cosmic Wind EP ARF has been flown with the ElectriFly Power Series 11.1V 1500mAh LiPo battery and the Flight Power EON-X™ Lite 11.1V 1600mAh LiPo battery packs. In our testing we found that if the APC 8x8E propeller was used with the recommended motor, the static current draw was approximately 24 amps.

- ElectriFly Power Series LiPo 1800mAh 11.1V 25C discharge w/balance plug [GPMP0515]
- FlightPower® EON-X Lite LiPo 1600mAh 11.1V 25C discharge w/balance plug [FPWP4146]

### Recommended Charger

A LiPo compatible charger is required to charge LiPo batteries. The Great Planes ElectriFly PolyCharge4™ is designed for LiPo packs only; however, it is able to charge four LiPo packs simultaneously. The ElectriFly Triton 2™ and AC/DC Triton2 EQ chargers will only charge one pack at a time, but are capable of charging NiCd, NiMH, Pb acid and LiPo batteries.

- Great Planes ElectriFly PolyCharger4 DC only 4 Output LiPo Charger (GPMM3015)
- OR**
- Great Planes ElectriFly Triton2 DC Computer Peak Charger (GPMM3153)

OR

- Great Planes AC/DC Triton2 EQ Charger/Balancer (GPMM3156)

Throughout the life of a LiPo battery, the individual cells located inside the battery may become unbalanced. These unbalanced cells can shorten the life of the battery or cause it to malfunction. For this reason, it is always recommended that a cell balancer be used when charging LiPo batteries. The ElectriFly Equinox™ is a cell balancer that may be used with any LiPo charger and is capable of maintaining the cell balance of the battery. Note: The AC/DC Triton2 EQ does not require a cell balancer.

- Great Planes ElectriFly Equinox LiPo Cell Balancer [GPMM3160]

## ADDITIONAL ITEMS REQUIRED

### Required Adhesives and Supplies

This is the list of adhesives and building supplies required to finish the Cosmic Wind EP. Order numbers are provided in parentheses.

- 1/2 oz. [15g] Thin Pro™ CA (GPMR6001)
- Pro 30-minute epoxy (GPMR6047)
- Canopy Glue (PAAR3300)
- Threadlocker thread locking cement (GPMR6060)
- Denatured alcohol (for epoxy clean up)
- Paper Towels
- Masking Tape
- Drill bits: 3/32" [2.4 mm] 3/64" or #60 [1 mm]
- #1 Hobby knife (HCAR0105)
- #11 blades (5-pack, HCAR0211)
- Small T-pins (100, HCAR5100)
- Non-elastic monofilament or Kevlar fishing line (for stabilizer alignment)
- Fine Line Marker

### Optional Supplies and Tools

Here is a list of optional tools mentioned in the manual that will help you build the Cosmic Wind EP.

- 2 oz. [57g] spray CA activator (GPMR6035)
- CA applicator tips (HCAR3780)
- CA debonder (GPMR6039)
- Epoxy brushes (6, GPMR8060)
- Mixing sticks (50, GPMR8055)
- Mixing cups (GPMR8056)
- AccuThrow™ Deflection Gauge (GPMR2405)
- CG Machine™ (GPMR2400)
- 21st Century® sealing iron [COCR2700]
- 21st Century iron cover [COVR2702]
- Soldering Iron
- Straightedge

## IMPORTANT BUILDING NOTES

- There are two types of screws used in this kit:

**Sheet Metal Screws** are designated by a number and a length. For example #6 × 3/4" [19mm].

*This is a number six screw that is 3/4" [19mm] long.*



**Machine Screws** are designated by a number, **threads per inch**, and a length. For example 4-40 × 3/4" [19mm].

*This is a number four screw that is 3/4" [19mm] long with forty threads per inch.*

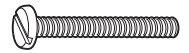

- When you see the term **test fit** in the instructions, it means that you should first position the part on the assembly **without using any glue**, then slightly modify or *custom fit* the part as necessary for the best fit.
- Whenever the term **glue** is written you should rely upon your experience to decide what type of glue to use. When a specific type of adhesive works best for that step, the instructions will make a recommendation.
- We recommend 30-minute epoxy only, because you will need the working time to position the part correctly and the additional strength.
- **Photos** and **sketches** are placed **before** the step they refer to. Frequently you can study photos in following steps to get another view of the same parts.
- The Cosmic Wind EP is factory-covered with Top Flite® MonoKote® film. Should repairs ever be required, MonoKote can be patched with additional MonoKote purchased separately. MonoKote is packaged in six-foot rolls, but some hobby shops also sell it by the foot. If only a small piece of MonoKote is needed for a minor patch, perhaps a fellow modeler would give you some. MonoKote is applied with a model airplane covering iron, but in an emergency a regular iron could be used. A roll of MonoKote includes full instructions for application. Following are the colors used on this model and order numbers for six foot rolls.

Missile Red - TOPQ0201  
Jet White - TOPQ0204

## KIT INSPECTION

Before starting to build, take an inventory of this kit to make sure it is complete, and inspect the parts to make sure they are of acceptable quality. If any parts are missing or are not of acceptable quality, or if you need assistance with assembly, contact **Product Support**. When reporting a defective or missing part, use the part names exactly as they are written in the Kit Contents list.

### Great Planes Product Support

3002 N Apollo Drive, Suite 1 Ph: (217) 398-8970, ext. 5  
Champaign, IL 61822 Fax: (217) 398-7721

E-mail: [airsupport@greatplanes.com](mailto:airsupport@greatplanes.com)

## ORDERING REPLACEMENT PARTS

Replacement parts for the Great Planes Cosmic Wind EP are available using the order numbers in the **Replacement Parts List** that follows. The fastest, most economical service can be provided by your hobby dealer or mail-order company.

To locate a hobby dealer, visit the Hobbico web site at [www.hobbico.com](http://www.hobbico.com). Choose "Where to Buy" at the bottom of the menu on the left side of the page. Follow the instructions provided on the page to locate a U.S., Canadian or International dealer. If a hobby shop is not available, replacement parts may also be ordered from Tower Hobbies® at [www.towerhobbies.com](http://www.towerhobbies.com), or by calling toll free (800) 637-6050.

Parts may also be ordered directly from Hobby Services by calling (217) 398-0007, or via facsimile at (217) 398-7721, but full retail prices and shipping and handling charges will apply. Illinois and Nevada residents will also be charged sales tax. If ordering via fax, include a Visa® or MasterCard® number and expiration date for payment.

Mail parts orders **Hobby Services**  
and payments by 3002 N Apollo Drive, Suite 1  
personal check to: Champaign IL 61822

Be certain to specify the order number exactly as listed in the **Replacement Parts List**. Payment by credit card or personal check only; no C.O.D.

If additional assistance is required for any reason contact Product Support by e-mail at [productsupport@greatplanes.com](mailto:productsupport@greatplanes.com), or by telephone at (217) 398-8970.

### For GPMA1810 Cosmic Wind EP ARF **Red**

Order No.	Description
GPMA4205	WING COSMIC WIND EP ARF
GPMA4206	FUSELAGE COSMIC WIND EP ARF
GPMA4207	TAIL SURFACES COSMIC WIND EP ARF
GPMA4208	CANOPY COSMIC WIND EP ARF
GPMA4209	LANDING GEAR COSMIC WIND EP ARF
GPMA4210	WHEELPANTS COSMIC WIND EP ARF
GPMA4211	SPINNER COSMIC WIND EP ARF
GPMA4212	HATCH COSMIC WIND EP ARF
GPMA4213	DECALS COSMIC WIND EP ARF

### For GPMA1811 Cosmic Wind EP ARF **White**

Order No.	Description
GPMA4175	WING COSMIC WIND EP ARF
GPMA4176	FUSELAGE COSMIC WIND EP ARF
GPMA4177	TAIL SURFACES COSMIC WIND EP ARF
GPMA4178	CANOPY COSMIC WIND EP ARF
GPMA4179	LANDING GEAR COSMIC WIND EP ARF
GPMA4180	WHEELPANTS COSMIC WIND EP ARF
GPMA4181	SPINNER COSMIC WIND EP ARF
GPMA4182	HATCH COSMIC WIND EP ARF
GPMA4183	DECALS COSMIC WIND EP ARF

## KIT CONTENTS

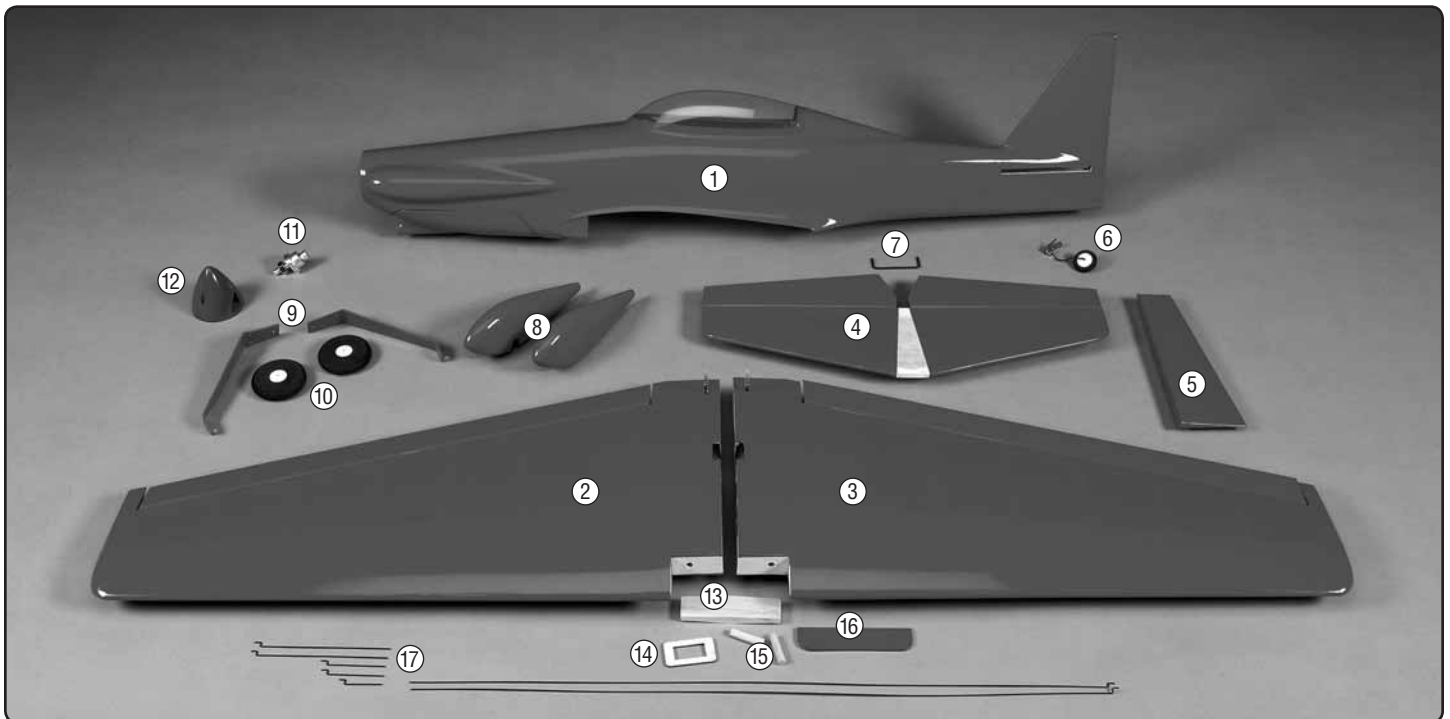

- |                          |                         |                        |
|--------------------------|-------------------------|------------------------|
| 1. Fuselage              | 7. Elevator Joiner Wire | 13. Wing Joiner        |
| 2. Right Wing Half       | 8. Wheel Pants          | 14. Aileron Servo Tray |
| 3. Left Wing Half        | 9. Main Landing Gear    | 15. Wing Dowels        |
| 4. Horizontal Stabilizer | 10. Main Wheels         | 16. Wing Bolt Plate    |
| 5. Rudder                | 11. Prop Adapter        | 17. Pushrods           |
| 6. Tail Wheel            | 12. Spinner             |                        |

## PREPARATIONS

- ❑ 1. If you have not done so already, remove the major parts of the kit from the box and inspect for damage. If any parts are damaged or missing, contact Product Support at the address or telephone number listed in the "Kit Inspection" section on page 4.



- ❑ 2. Check the covering on the wing, stabilizer and rudder. Use a covering iron with a covering sock on medium heat to tighten the covering if necessary. Apply pressure over sheeted areas to **thoroughly** bond the covering to the wood.

## ASSEMBLE THE WING

### Join the Wing Halves

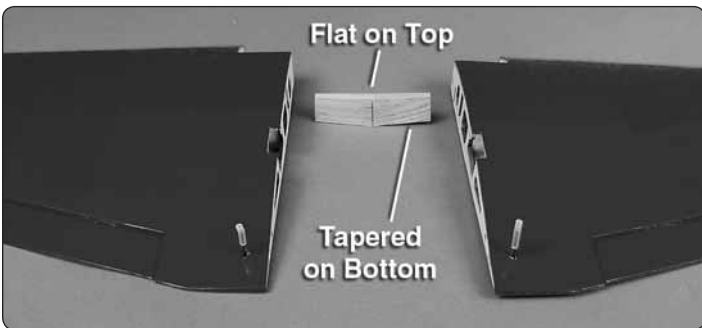

- ❑ 1. Test fit the hardwood **wing joiner** in the two **wing halves**. Note that one edge of the wing joiner is flat and the other edge is tapered. The flat edge is positioned towards the top of the wing. With the wing joiner properly installed both wing tips should be off of the table. Check that there is no gap between the two wing halves at the wing root.

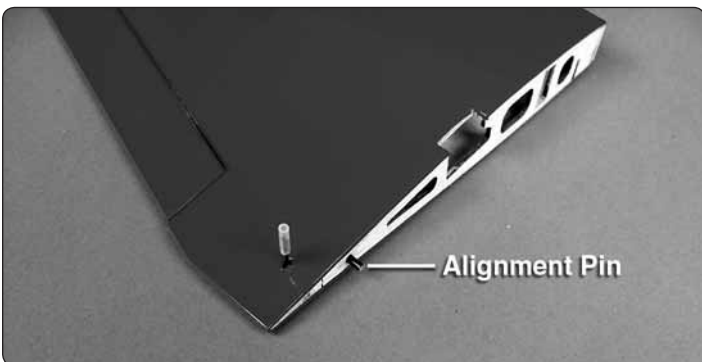

- ❑ 2. Insert the **3 × 15mm alignment pin** half way into the root rib of one wing half. Use thin CA to glue it in position.

- ❑ 3. Mix together  $\frac{1}{2}$  oz. [15cc] of 30-minute epoxy. Coat the inside of wing joiner cavity in both of the wing halves. Apply epoxy to half of the wing joiner and insert it into one of the wing halves. Apply epoxy to the other half of the wing joiner and the root rib of both wing halves. Join the second wing half to the first. Wipe off any excess epoxy with a paper towel dampened with denatured alcohol. Hold the two wing halves together with masking tape until the epoxy has cured.

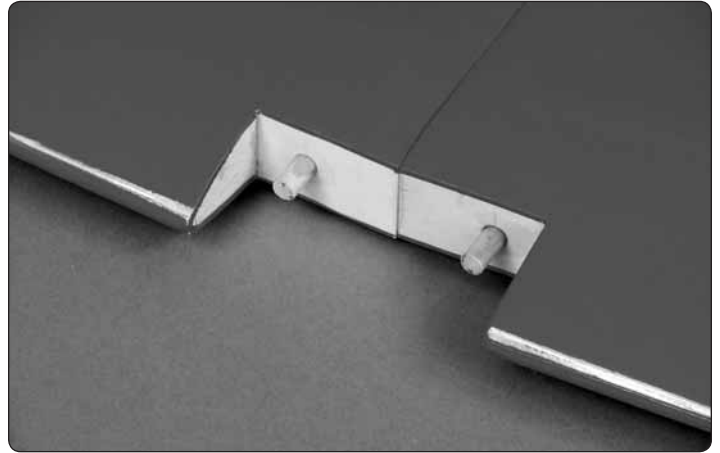

- ❑ 4. Insert the two  $\frac{1}{4} \times 1$ " [6 × 25 mm] **wood wing dowels** in the leading edge of the wing. Glue the wing dowels to the wing with thin CA glue.

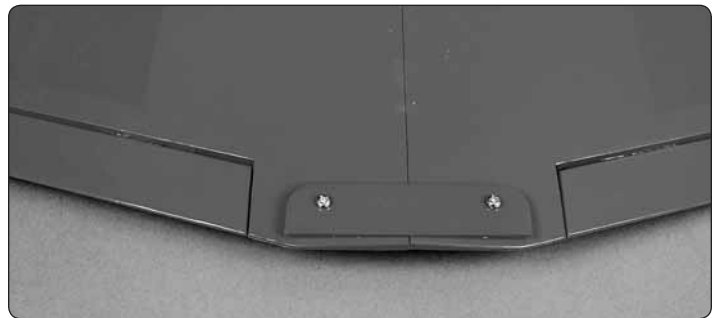

- ❑ 5. Remove the covering from the two wing bolt holes in the wing and the **wing bolt plate**. Position the wing bolt plate on the bottom of the wing and insert the two **3 × 18mm wing bolts** to hold it in position.

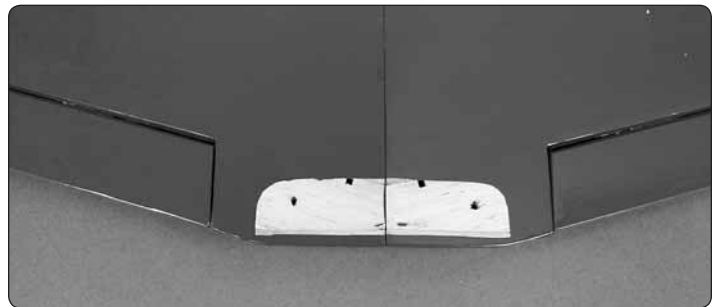

- ❑ 6. Use a fine line marker to mark the outline of the wing bolt plate on the bottom of the wing. Remove the wing bolt plate. Using a sharp hobby knife cut and remove the covering from the wing, inside the outline of the wing bolt plate. Do not cut the balsa wing sheeting.

- ❑ 7. Glue the wing bolt plate to the bottom of the wing using the wing bolts to align the wing bolt plate with the wing.

## ASSEMBLE THE FUSELAGE

### Install the Main Landing Gear

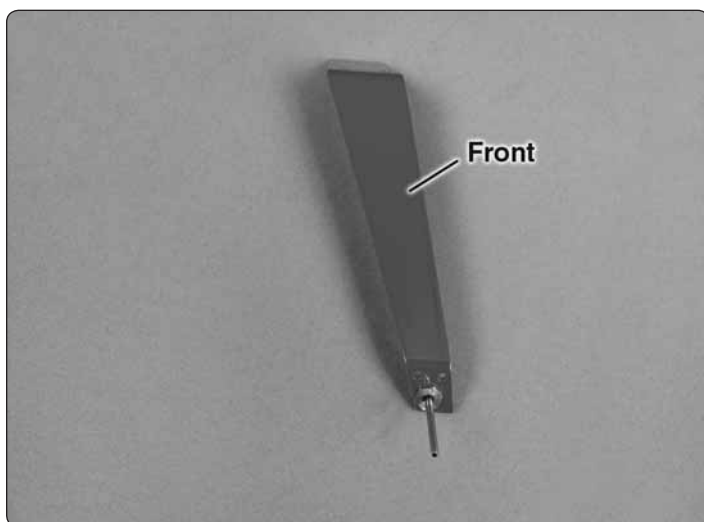
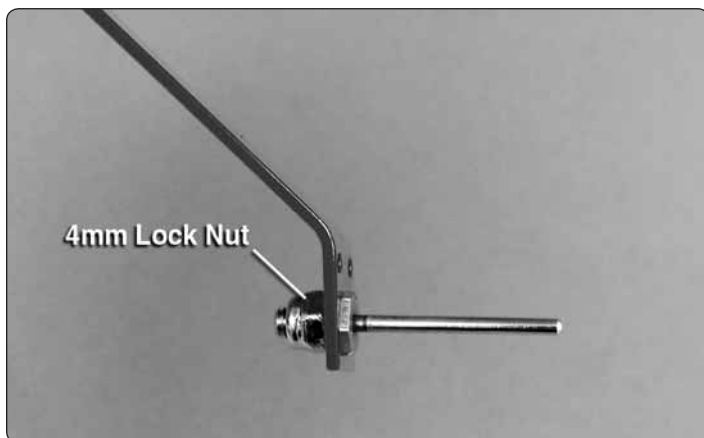

- 1. Insert a **2mm axle** through the **right main landing gear**. Secure the axle to the landing gear with a **4mm lock nut**. **Note:** the front of the main landing gear sweeps forward.

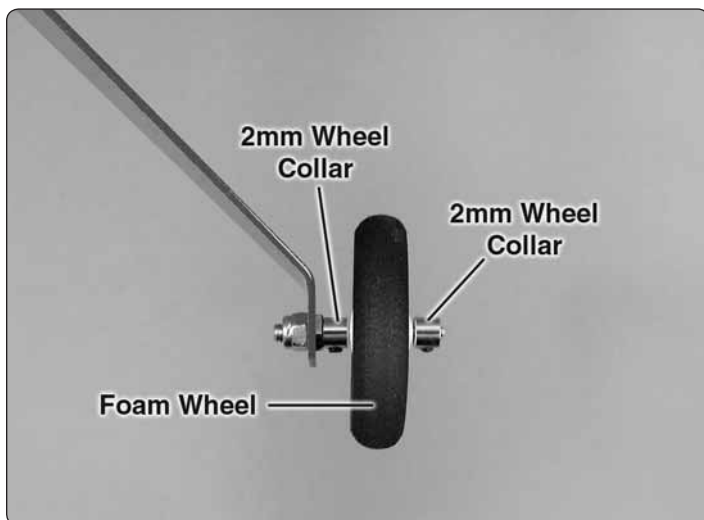

- 2. Install a **2mm wheel collar** on the axle, then the **foam main wheel**, followed by a second **2mm wheel collar**. Apply a drop of thread locker on the **3mm set screws** and secure the wheel collars on the axle with the set screws.

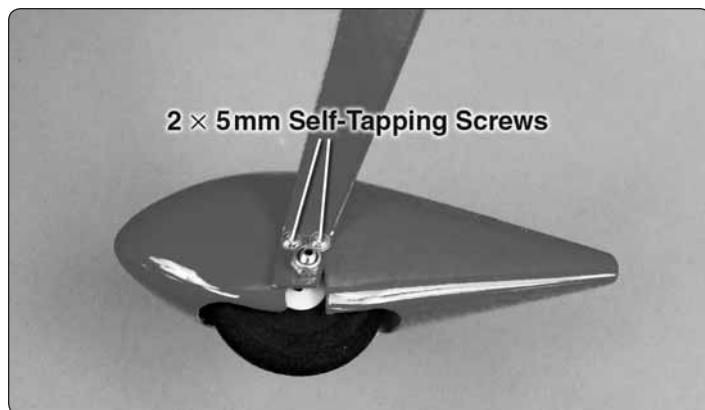

- 3. Position the right wheel pant over the wheel and secure it to the main landing gear with two **2 × 5mm self tapping screws**.



- 4. Attach the main landing gear to the **fuselage** with three **2.5 × 8mm self tapping screws**.

- 5. Repeat steps 1–4 for the left main landing gear.

### Install the Stabilizer



- 1. Attach the wing to the fuselage with two **3 × 18mm wing bolts** and two **3mm flat washers**.

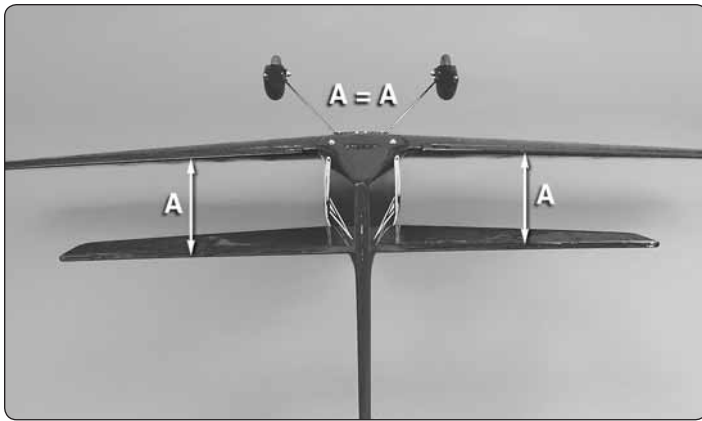

❑ 2. Center the **horizontal stabilizer** in the slot in the fuselage. Stand back and look at the stab in relation to the wing. The stab should be parallel with the wing. If not, sand the stab saddle until the stab and wings are aligned.

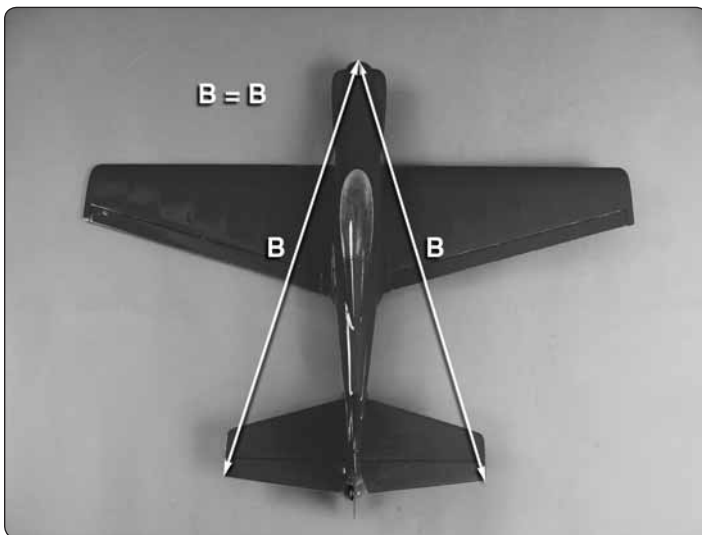

❑ 3. Measure the distance from the tip of the stab to the center of the fuselage. Adjust the position of the stab until they are equal.

❑ 4. Using a fine-point felt-tip pen, mark the outline of the fuselage on the top and the bottom of the stab.

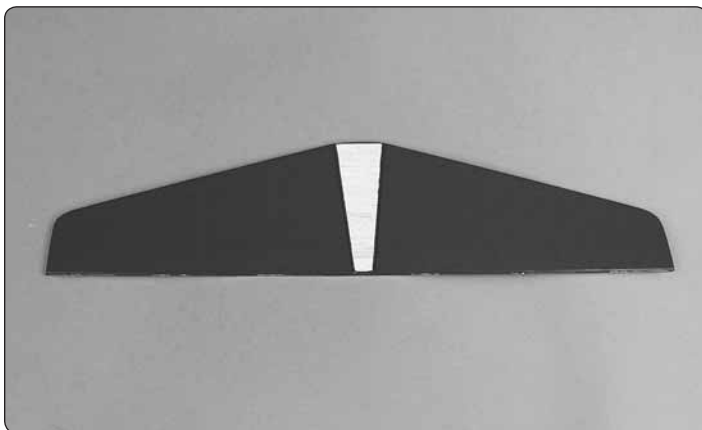

❑ 5. Cut the covering on the top and bottom of the stab inside the line you have drawn. Use care to cut **only into the covering** and **not** into the wood.



### HOW TO CUT COVERING FROM Balsa

Use a soldering iron to cut the covering from the stabilizer. The tip of the soldering iron doesn't have to be sharp, but a fine-tip does work best. Allow the iron to heat fully.

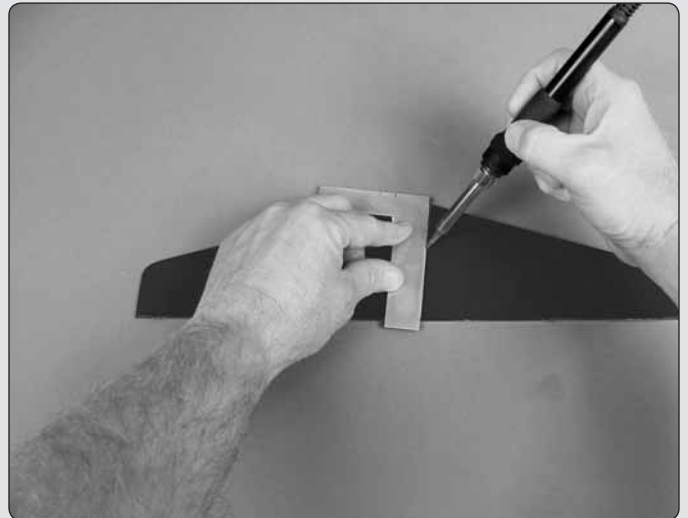

Use a straightedge to guide the soldering iron at a rate that will just melt the covering and not burn into the wood. The hotter the soldering iron, the faster it must travel to melt a fine cut. Peel off the covering.

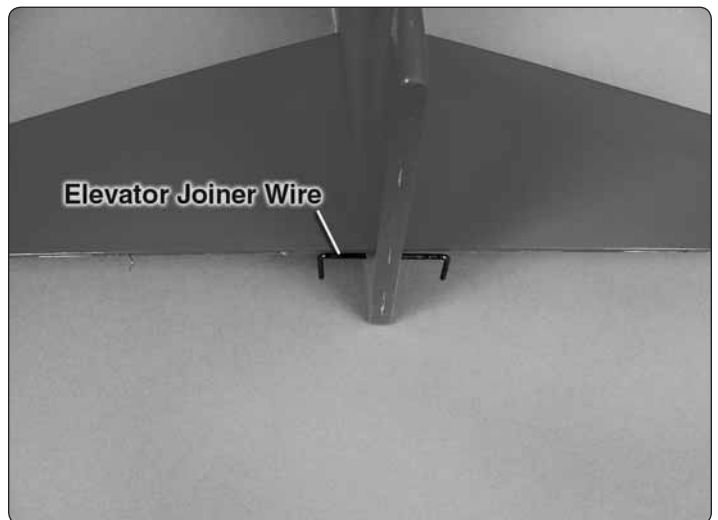

❑ 6. Wipe away the lines you drew. Insert the **elevator joiner wire** in the notch at the back of the stab saddle. Use epoxy to glue the stab in place, being careful that the stab is properly aligned. Wipe off any excess epoxy from the stab and fuselage with a paper towel dampened with denatured alcohol. Recheck that the stab is still aligned.

You can now remove the wings and continue with the assembly of the fuselage.



## Install the Elevators and Rudder

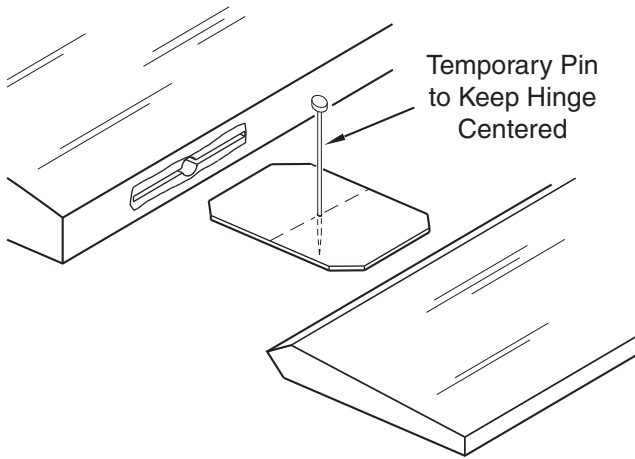
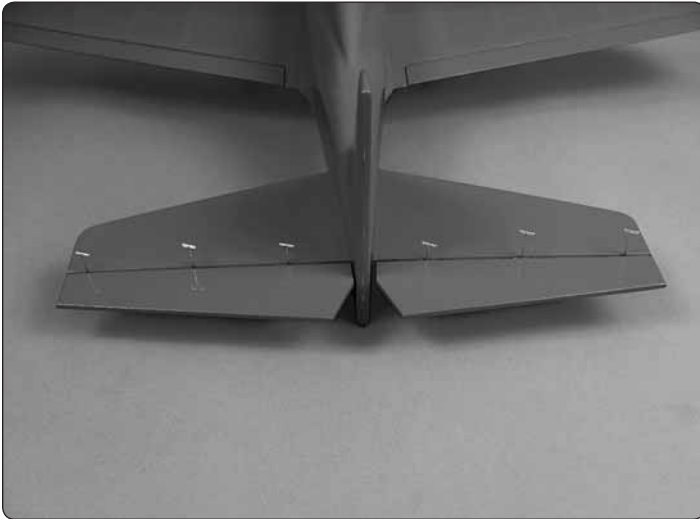

❑ 1. Test fit the **elevators** to the horizontal stabilizer with the elevator joiner wire in each elevator half and six **10×15mm CA hinges**. If the hinges don't remain centered, stick a pin through the middle of the hinge to hold it in position. Check that both elevator halves are aligned. If not, remove the elevators and while holding one leg of the elevator joiner wire, slightly bend the other. Reinstall the elevator halves and check again.

❑ 2. Coat the inside of the two elevator joiner wire holes and the ends of the elevator joiner wire with 30-minute epoxy. Install the two elevator halves and remove any pins you may have inserted into the hinges. Adjust the elevators so there is a small gap between the LE of the elevators and the horizontal stabilizer. The gap should be small, just enough to see light through or to slip a piece of paper through.

❑ 3. Apply four drops of thin CA to the top and bottom of each hinge. Allow the CA to wick along the hinge. Do not use CA accelerator. After the CA has fully hardened, test the hinges by pulling on the elevator.

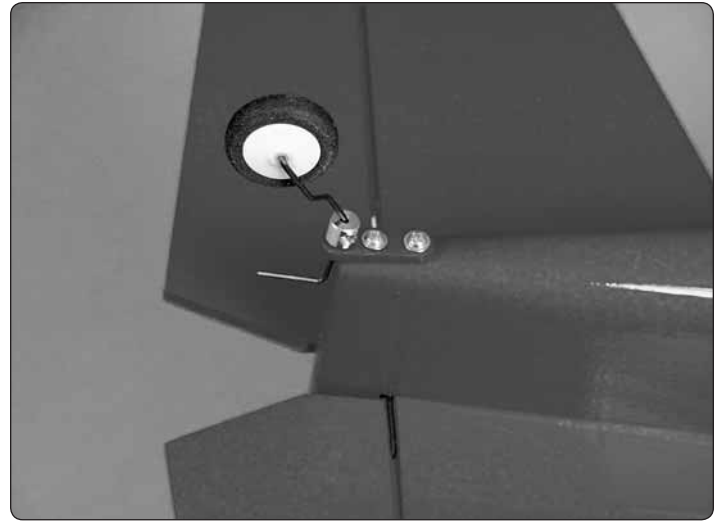

❑ 4. Attach the **tail gear** to the bottom of the fuselage with two **2 mm self tapping screws**.

❑ 5. As with the elevators, insert pins into the center of the hinges and install the hinges in the **rudder**. Insert the tail gear wire in the rudder and check the fit of the rudder on the fin.



❑ 6. Coat the inside of the tail gear wire hole and the end of the tail gear wire with 30-minute epoxy. Install the rudder on the fin and remove the pins. Apply four drops of thin CA to the hinges.

❑ 7. Use a **3 mm set screw** to secure the 2mm wheel collar on the tail wheel wire.

## Install the Motor

The Cosmic Wind EP has been designed to use the ElectriFly RimFire .10 Outrunner Brushless motor. If you will be installing a different motor, you may need to modify the plywood motor plate in the front of the fuselage.



- ❑ 1. Remove the brass wheel collar from the RimFire .10 motor.

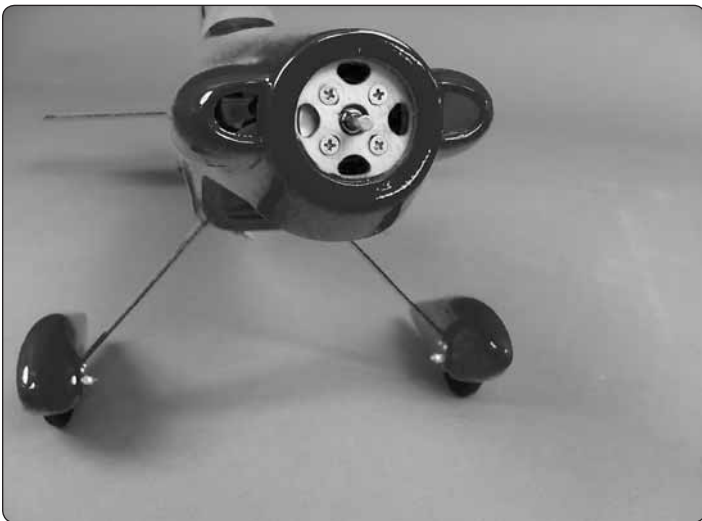

- ❑ 2. Install the RimFire .10 motor using the four 3×9mm machine screws and 3mm flat washers. Before installing each screw, apply a drop of threadlocker to the threads of the screw. Make sure the motor is centered on the plywood motor mount.

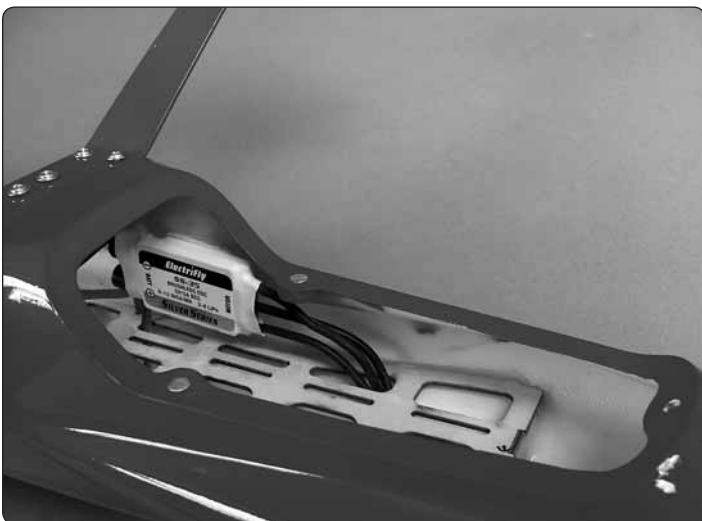

- ❑ 3. Connect the ESC to the motor. The ESC can be attached to the side of the fuselage with **adhesive backed hook and loop material**.

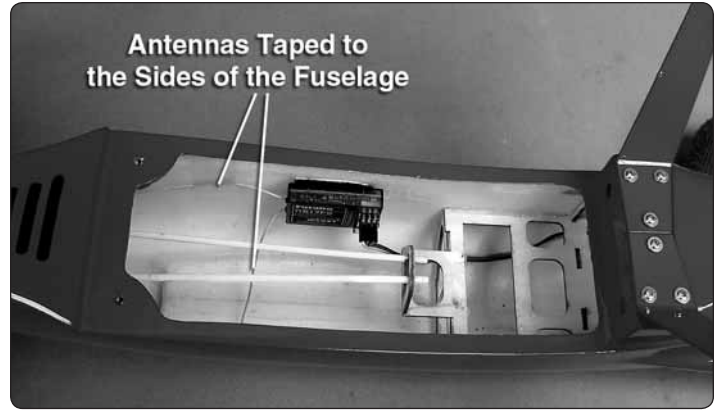

- ❑ 4. Use adhesive backed hook and loop material to mount the receiver to the side of the fuselage. Tape the two antennas to the sides of fuselage. If using a 72 MHz receiver, route the antenna out the cooling exit holes and tape it to the bottom of the fuselage.

## INSTALL THE RADIO SYSTEM

### Install the Elevator Servo

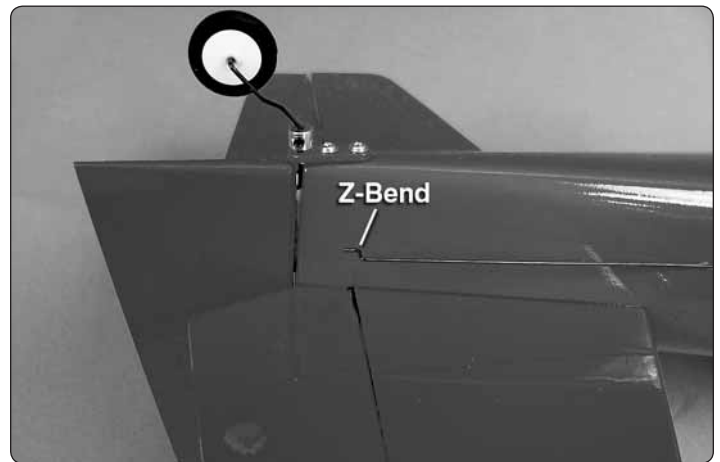

- ❑ 1. Insert one of the long **1 mm wire pushrods** in the left pushrod tube so that the Z-bend is at the aft end of the fuselage.

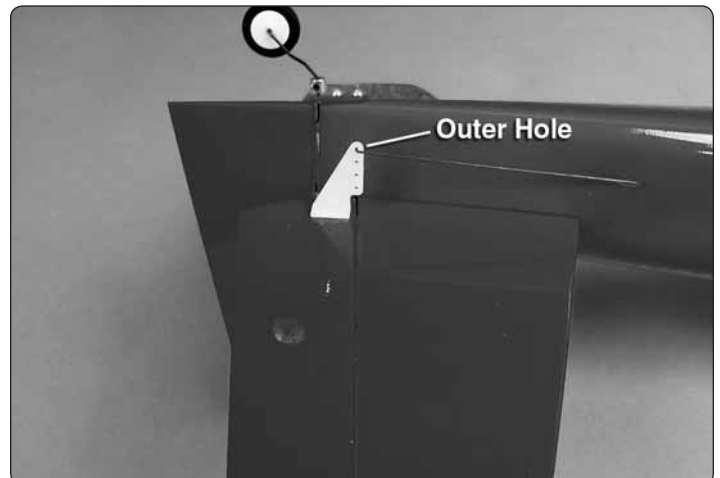

- ❑ 2. Use a sharp hobby knife to remove the backplate from the **large nylon control horn**. Insert the elevator pushrod wire in the outer most hole of the control horn.

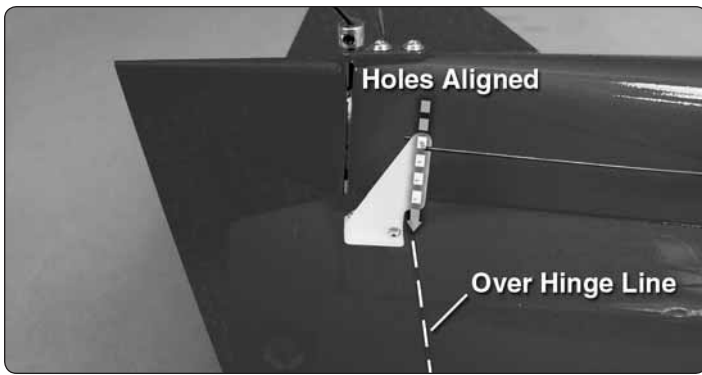

❑ 3. Using the elevator pushrod wire, position the control horn so that the four pushrod holes are in line with the elevator hinge line. Mark the location of the mounting holes onto the elevator. Drill a 3/32" [2.5mm] hole on the marks, drilling through the elevator. Attach the control horn to the elevator using two **2-56 x 1/2" [12mm] machine screws** and the **control horn back plate**. Remove the screws and apply a couple of drops of thin CA to both holes to harden the wood. Then, reinstall the control horn.

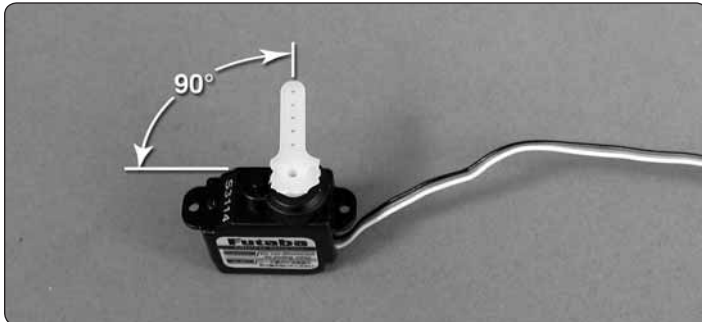

❑ 4. Connect a servo to the elevator output on the receiver. Switch on the receiver and transmitter and center the elevator trims. Install a servo arm on the servo so that it is perpendicular to the centerline of the servo.

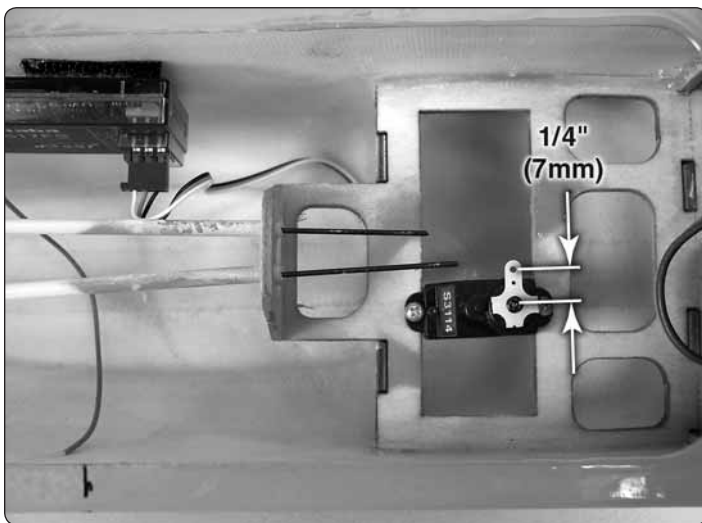

❑ 5. Position the elevator servo in the servo tray so that the hole 1/4" (7mm) from the center of the servo arm is in line with the pushrod wire. The servos can either be glued to the servo tray with medium CA or attached with **2 x 6 mm self tapping screws**. The screws do not require a pilot hole; just thread them into the plywood tray.



❑ 6. Apply a drop of threadlocker to two cap screws and install them into two wheel collars. Slide the two wheel collars over the elevator pushrod.

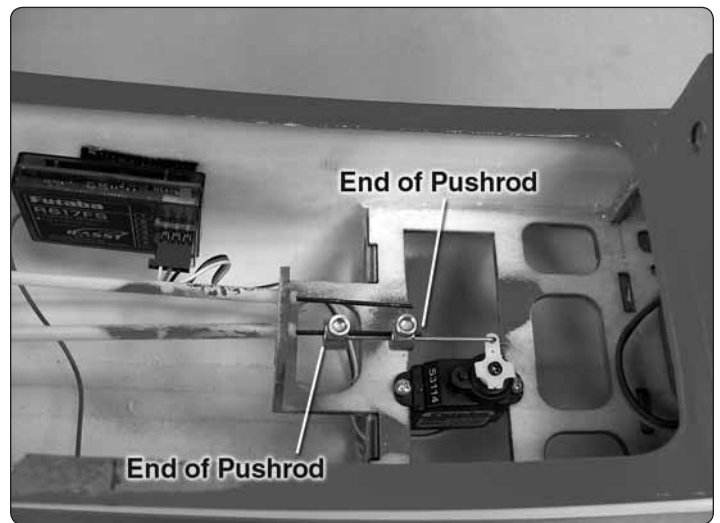

❑ 7. Enlarge the hole in the servo arm with a #60 or 3/64" [1mm] drill bit. Insert the Z-bend of a 1 x 25 mm pushrod into the hole 1/4" (7mm) from the center of the elevator servo arm. Slide the wheel collars over the two pushrods, positioning them so that they are close to the ends of the two pushrods. Tighten the cap screws against the pushrods.

❑ 8. Switch your radio system on and center the servo arm and elevators. Tighten the cap screws against the pushrods.

## Install the Rudder Servo

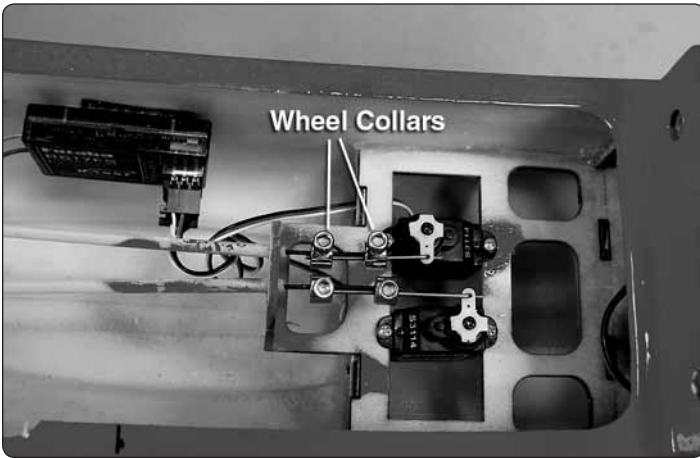
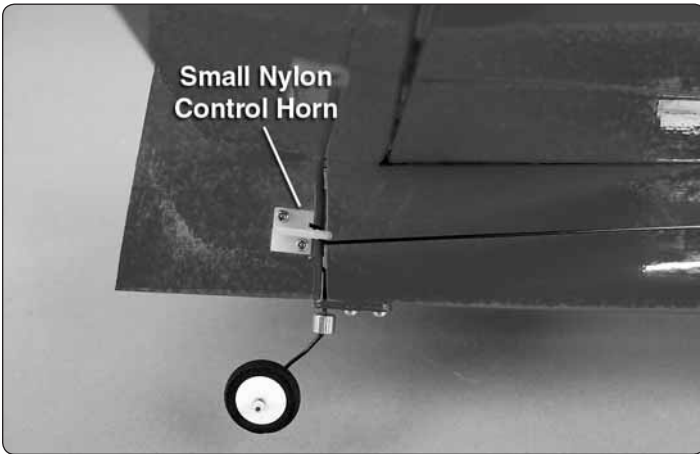

- ❑ 1. Install the rudder servo following the same procedure used to install the elevator servo. Note: Use the **small nylon control horn** on the rudder.

## Install the Aileron Servo

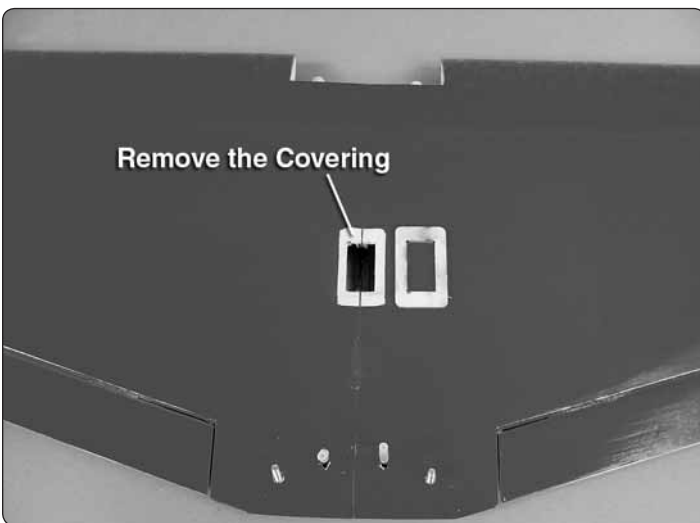

- ❑ 1. Place the **aileron servo tray** over the aileron servo opening in the top of the wing. Use a fine tip marker to mark the outline of the aileron tray on the top of the wing. Remove the tray and use a sharp hobby knife to remove the covering from inside the marks. Be careful not to cut the balsa sheeting.

- ❑ 2. Glue the aileron servo tray over the aileron servo opening.

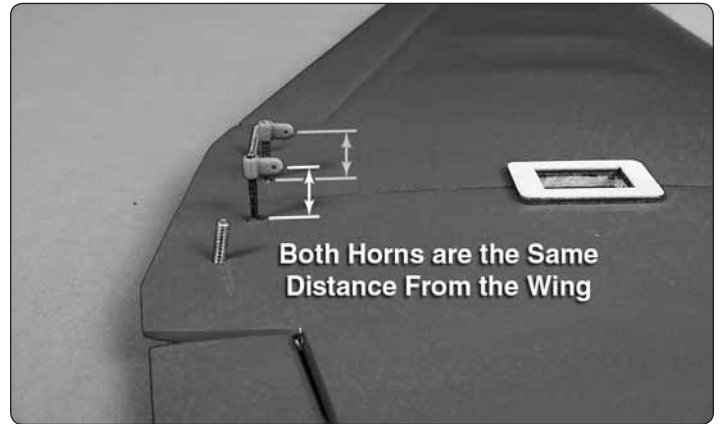

- ❑ 3. Remove the rubber aileron torque rod thread protectors. Thread an **aileron torque rod horn** on to both aileron torque rods so that the threads are flush with the top of the torque rod horns. Adjust the horns so that both of them are the same distance from the wing.

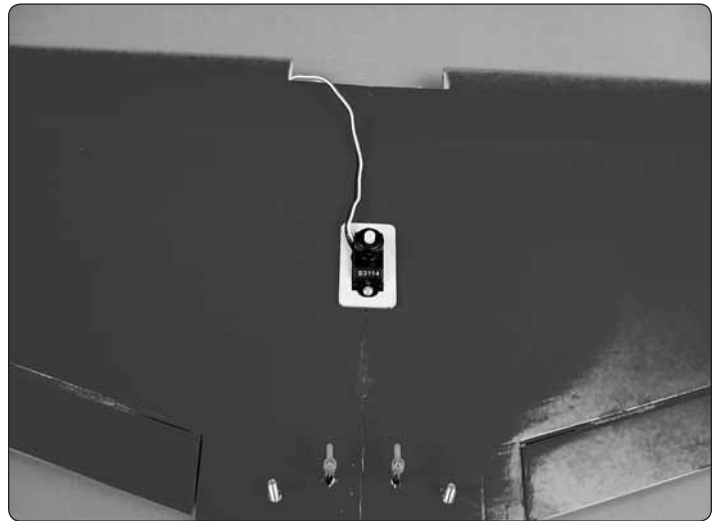

- ❑ 4. Attach the aileron servo to the servo tray either with glue or 2 x 6 mm self tapping screws.

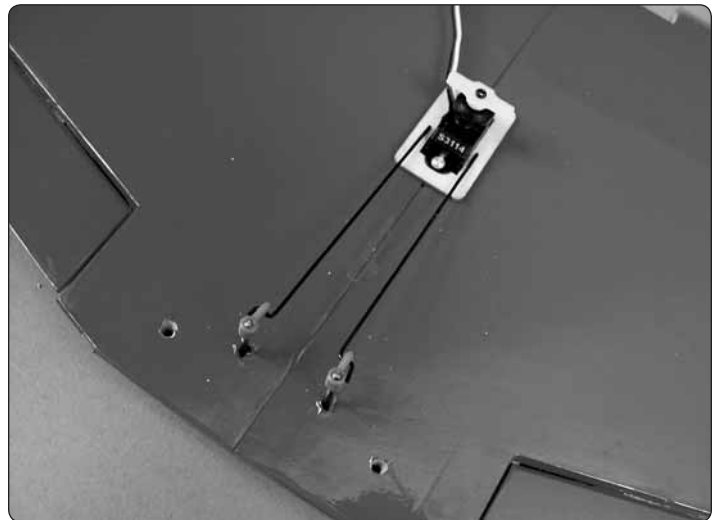

- ❑ 5. Insert the Z-bend of the **1 x 70 mm aileron pushrod wires** in the two aileron torque rod horns.

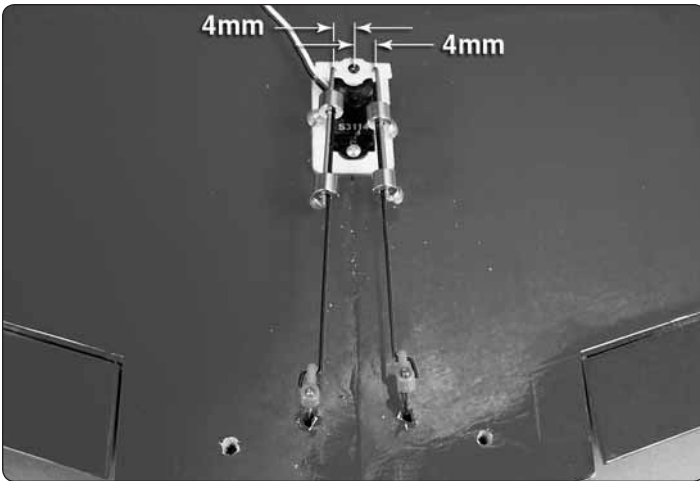

❑ 6. Apply a drop of threadlocker to the threads of four cap screws. Thread the cap screws into four wheel collars. Slide the wheel collars over the aileron pushrods. Insert the two 1 x 25mm pushrods 4mm from the center of the servo arm. Slide the wheel collars over the 1 x 25mm pushrods.

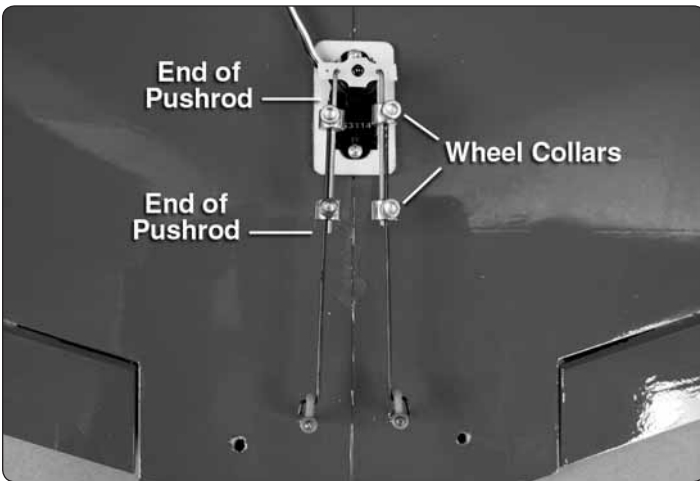

❑ 7. Center the aileron servo arm and the ailerons. Tighten the cap screws against the pushrods at the end of the pushrods.

## FINISH THE MODEL

### Install the Battery Straps



❑ 1. Insert the piece of **hook material** in one of the slots of the battery tray. Insert the **loop material** in the opposite slot. Press the hook and loop material together under the battery tray to make a battery strap.

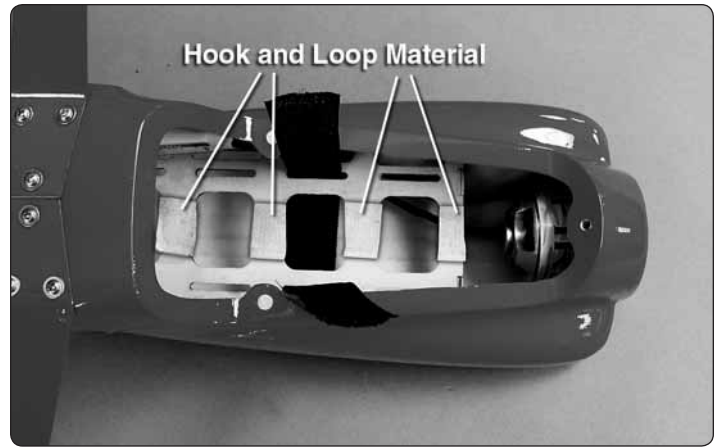

❑ 2. Cut and attach several pieces of the included adhesive backed hook or loop material to the top of the battery tray. Attach the opposite piece of the hook and loop material to the back of your flight battery.

### Install the Canopy



❑ 1. For our model we used the head from the Williams Brothers 1/6 Scale Sportsman Pilot #18400 [WBRQ1140]. The pilot head had to be trimmed just under the nose to fit under the **canopy**.

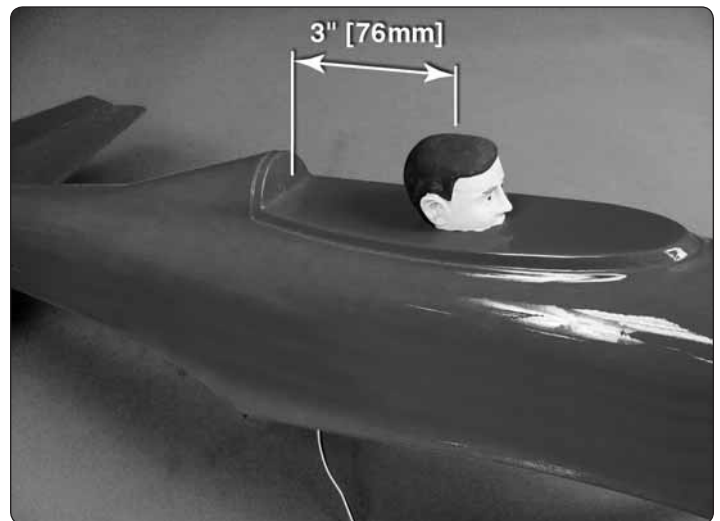

❑ 2. Clean the cockpit surface with denatured alcohol and a clean paper towel. Glue the pilot head in the cockpit, approximately 3" [76mm] from the back of the cockpit.

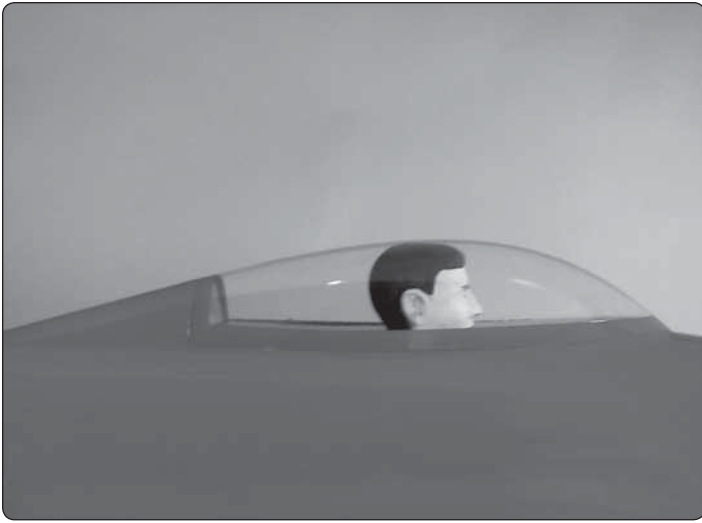

- ❑ 3. Clean the inside of the canopy with soap and water and dry thoroughly. Glue the canopy to the fuselage with canopy glue such as Pacer Technology's PT56 Canopy Glue [PAAR3300].

### Apply the Decals

The box photographs show the location of the decals on the airplane. Refer to the box for the exact placement of the decals. The following tips may be useful for applying them.

- ❑ 1. Use scissors or a sharp hobby knife to cut the **decals** from the sheet.
- ❑ 2. Be certain the model is clean and free from oily fingerprints and dust. Prepare a dishpan or small bucket with a mixture of liquid dish soap and warm water—about one teaspoon of soap per gallon of water. Submerge the decal in the soap and water and peel off the paper backing. **Note:** Even though the decals have a “sticky-back” and are not the water transfer type, submersing them in soap & water allows accurate positioning and reduces air bubbles underneath.
- ❑ 3. Position decals on the model. Holding the decal down, use a paper towel to wipe most of the water away.
- ❑ 4. Use a piece of soft balsa or something similar to squeegee remaining water from under the decal. Apply the rest of the decals the same way.

## GET THE MODEL READY TO FLY

### Check the Control Directions

- ❑ 1. Turn on the transmitter and receiver and center the trims. If necessary, remove the servo arms from the servos and reposition them so they are centered. Reinstall the screws that hold on the servo arms.
- ❑ 2. With the transmitter and receiver still on, check all the control surfaces to see if they are centered. If necessary, loosen the screw in the quick connector and center the control surfaces.

### 4-CHANNEL RADIO SETUP (Standard Mode 2)

RUDDER  
MOVES RIGHT

RIGHT AILERON MOVES UP  
LEFT AILERON MOVES DOWN

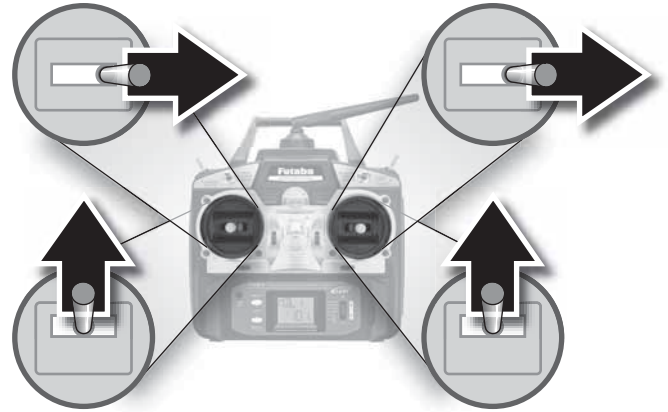

FULL THROTTLE

ELEVATOR MOVES DOWN

- ❑ 3. Make certain that the control surfaces respond in the correct direction as shown in the diagram. If any of the controls respond in the wrong direction, use the servo reversing in the transmitter to reverse the servos connected to those controls. Be certain the control surfaces have remained centered. Adjust if necessary.

### Set the Control Throws

To ensure a successful first flight, set up your Cosmic Wind EP according to the control throws specified in this manual. The throws have been determined through actual flight testing and accurate record-keeping, allowing the model to perform in the manner in which it was intended.

- ❑ 1. Use a box or something similar to prop up the bottom of the fuselage so the horizontal stabilizer and wing will be level.
- ❑ 2. Measure the high rate elevator throw first. Hold a ruler vertically on your workbench against the widest part (front to back) of the trailing edge of the elevator. Note the measurement on the ruler.

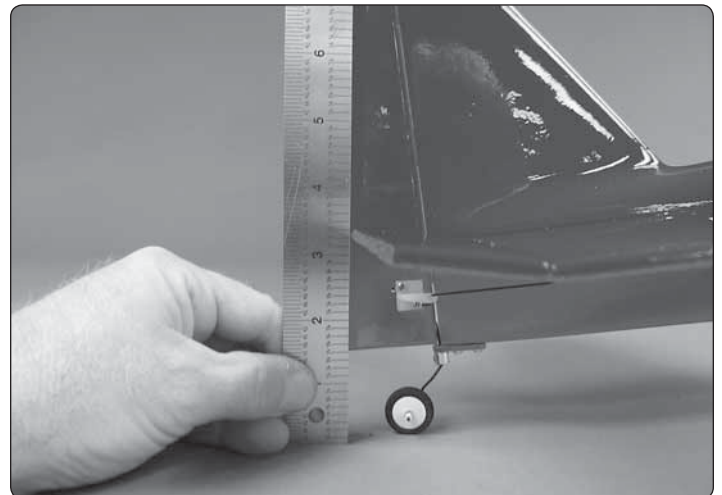

- ❑ 3. Move the elevator up with your transmitter and move the ruler forward so it will remain contacting the trailing edge. The

distance the elevator moves up from center is the “up” elevator throw. Measure the down elevator throw the same way.

4. Measure and set the **low rate** elevator throws and the high and low rate throws for the rest of the control surfaces the same way.

If your radio does not have dual rates, we recommend setting the throws at the high rate settings.

**NOTE:** The throws are measured at the **widest part** of the elevators, rudder and ailerons.

These are the recommended control surface throws:		
	<b>LOW RATE</b>	<b>HIGH RATE</b>
<b>ELEVATOR</b>	<b>Up &amp; Down</b> 1/8" [3mm] 4°	<b>Up &amp; Down</b> 1/4" [6mm] 8°
<b>RUDDER</b>	<b>Right &amp; Left</b> 3/8" [10mm] 10°	<b>Right &amp; Left</b> 9/16" [14mm] 14°
<b>AILERONS</b>	<b>Up &amp; Down</b> 1/8" [3mm] 7°	<b>Up &amp; Down</b> 3/16" [5mm] 11°

**CAUTION:** The throws appear to be small. However, the model has been extensively flown and tested to arrive at the throws at which it flies best. Flying your model at these throws will provide you with the greatest chance for successful first flights. Increasing the throws can cause the plane to be very difficult to fly.

### Install the Propeller

Insert the motor battery in the fuselage. Switch on the transmitter and connect the motor battery to the ESC. While securely holding the plane, slowly advance the throttle. The motor should rotate counterclockwise when viewed from the front. If it rotates the wrong direction, switch two of the three motor wires.



1. Slide the collet type prop adaptor on the motor shaft.

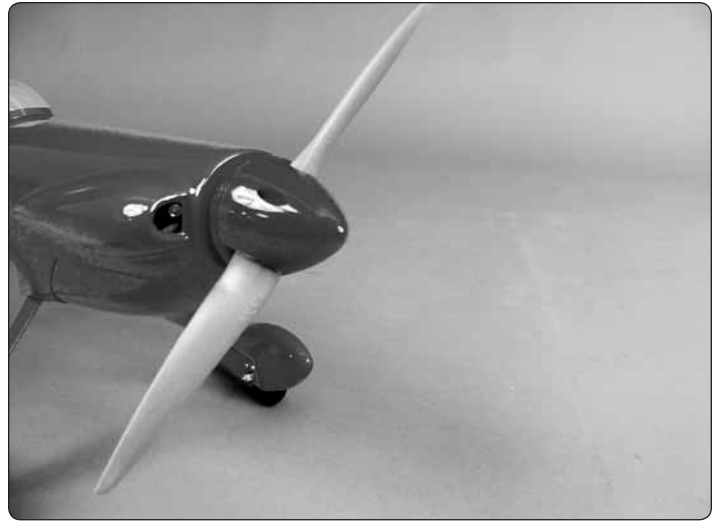

2. Use a prop reamer or drill bit to enlarge the **spinner back plate** to fit your motor's prop adapter. Install the spinner back plate, propeller with washer and prop nut and the **spinner cone**. Secure the spinner cone to the back plate with two **2.5 x 7 mm Sheet metal screws**.

3. Insert a flight battery in the fuselage and use the hook and loop material to hold the battery in position. **Do not connect the battery to the ESC while balancing the model.**

4. Install the battery hatch cover.

### Balance the Model (C.G.)

More than any other factor, the **C.G.** (balance point) can have the **greatest** effect on how a model flies, and may determine whether or not your first flight will be successful. If you value this model and wish to enjoy it for many flights, **DO NOT OVERLOOK THIS IMPORTANT PROCEDURE.** A model that is not properly balanced will be unstable and possibly unflyable.

At this stage the model should be in ready-to-fly condition with all of the systems in place including the motor, landing gear, battery and the radio system.

1. Use a felt-tip pen or 1/8" [3mm]-wide tape to accurately mark the C.G. on the top of the wing at the side of the fuselage. The C.G. is located 2–1/16" [52mm] back from the leading edge of the wing at the side of the fuselage.

This is where your model should balance for the first flights. Later, you may wish to experiment by shifting the C.G. up to 3/16" [4.5mm] forward or 3/16" [4.5mm] back to change the flying characteristics. Moving the C.G. forward may improve the smoothness and stability, but the model may then require more speed for takeoff and make it more difficult to slow for landing. Moving the C.G. aft makes the model more maneuverable, but could also cause it to become too difficult to control. In any case, **start at the recommended balance point** and do not at any time balance the model outside the specified range.

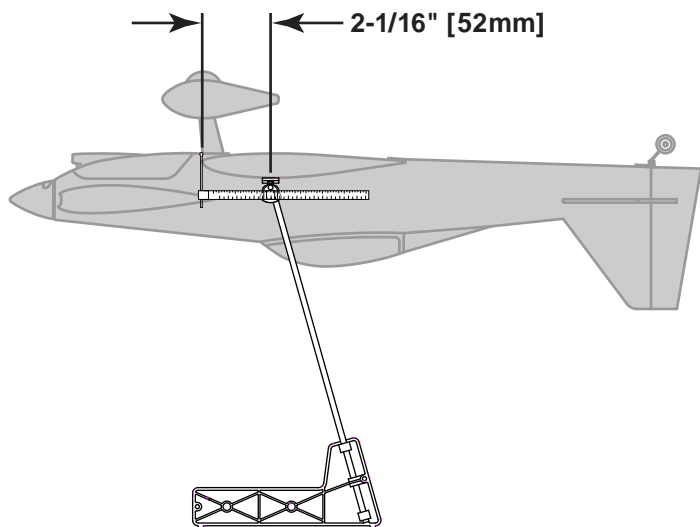

2. With the wing attached to the fuselage, and all parts of the model installed (ready to fly), lift it at the balance point you marked.

3. If the tail drops, the model is “tail heavy” and the battery pack must be shifted forward or weight must be added to the nose to balance. If the nose drops, the model is “nose heavy” and the battery pack must be shifted aft or weight must be added to the tail to balance. If additional weight is required, use Great Planes (GPMQ4485) “stick-on” lead. A good place to add stick-on nose weight is next to the motor, inside the fuselage (don’t attach weight to the battery hatch cover—it is not intended to support weight). Begin by placing incrementally increasing amounts of weight on the fuse until the model balances. Once you have determined the amount of weight required, it can be permanently attached.

4. **IMPORTANT:** If you found it necessary to add any weight, recheck the C.G. after the weight has been installed.

### ***Balance the Model Laterally***

1. With the wing level, have an assistant help you lift the model by the engine propeller shaft and the bottom of the fuse under the TE of the fin. Do this several times.

2. If one wing always drops when you lift the model, it means that side is heavy. Balance the airplane by adding weight to the other wing tip. **An airplane that has been laterally balanced will track better in loops and other maneuvers.**

## ***PREFLIGHT***

### ***Identify Your Model***

No matter if you fly at an AMA sanctioned R/C club site or if you fly somewhere on your own, you should always have your name, address, telephone number and AMA number on or inside your model. It is **required** at all AMA R/C club flying sites and AMA sanctioned flying events. Fill out the identification tag on page 19 and place it on or inside your model.

### ***Charge the Batteries***

Follow the battery charging instructions that came with your radio control system to charge the batteries. You should always charge your transmitter batteries the night before you go flying, and at other times as recommended by the radio manufacturer.

**CAUTION:** Unless the instructions that came with your radio system state differently, the **initial** charge on **new** transmitter and receiver batteries should be done for 15 hours **using the slow-charger that came with the radio system**. This will “condition” the batteries so that the next charge may be done using the fast-charger of your choice. If the initial charge is done with a fast-charger the batteries may not reach their full capacity and you may be flying with batteries that are only partially charged.

### ***Balance the Propellers***

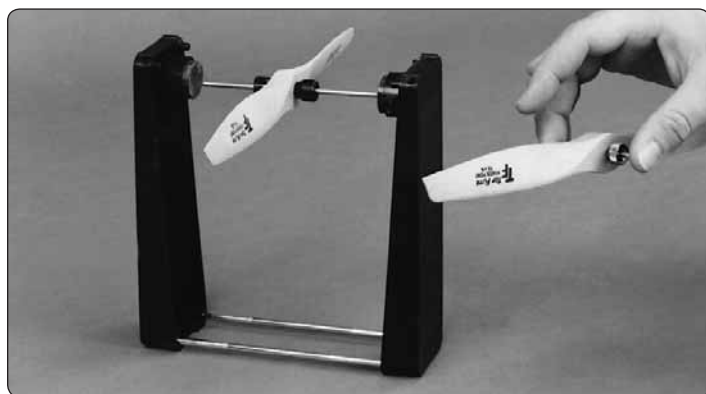

Carefully balance your propeller and spare propellers before you fly. An unbalanced prop can be the single most significant cause of vibration that can damage your model. Not only will motor mounting screws and bolts loosen, possibly with disastrous effect, but vibration may also damage your radio receiver and battery.

We use a Top Flite Precision Magnetic Prop Balancer (TOPQ5700) in the workshop and keep a Great Planes Fingertip Prop Balancer (GPMQ5000) in our flight box.

### ***Range Check***

Ground check the operational range of your radio before the first flight of the day. With the transmitter antenna collapsed and the receiver and transmitter on, you should be able to walk at least 100 feet away from the model and still have control. Have an assistant stand by your model and, while you work the controls, tell you what the control surfaces are doing. Repeat this test **with the motor running** at various speeds with an assistant holding the model, using hand signals to show you what is happening. If the control surfaces do not respond correctly, **do not fly!** Find and correct the problem first. Look for loose servo connections or broken wires, corroded wires on old servo connectors, poor solder joints in your battery pack or a defective cell, or a damaged receiver crystal from a previous crash. The problem may be the location of the



antenna. The antenna should be as far away from the ESC and battery as possible.

## MOTOR SAFETY PRECAUTIONS

Failure to follow these safety precautions may result in severe injury to yourself and others.

- Get help from an experienced pilot when learning to operate electric motors.
- Use safety glasses when running electric motors.
- Do not run the motor in an area of loose gravel or sand; the propeller may throw such material in your face or eyes.
- Keep your face and body as well as all spectators away from the plane of rotation of the propeller as you run the motor.
- Keep these items away from the prop: loose clothing, shirt sleeves, ties, scarfs, long hair or loose objects such as pencils or screwdrivers that may fall out of shirt or jacket pockets into the prop.
- The motor gets hot! Do not touch it during or right after operation.
- When working on your plane, remove the propeller if the motor battery will be connected.
- Always remove the motor battery from the plane when charging.
- Follow the charging instructions included with your charger for charging LiPo batteries. LiPo batteries can cause serious damage if misused.

**Remember:** Once the motor battery is plugged in, the motor could start at any time. If you are working on the model, remove the propeller.

## AMA SAFETY CODE

Read and abide by the following excerpts from the Academy of Model Aeronautics Safety Code. For the complete Safety Code refer to *Model Aviation* magazine, the AMA web site or the Code that came with your AMA license.

### General

- 1) I will not fly my model aircraft in sanctioned events, air shows, or model flying demonstrations until it has been proven to be airworthy by having been previously, successfully flight tested.
- 2) I will not fly my model aircraft higher than approximately 400 feet within 3 miles of an airport without notifying the airport operator. I will give right-of-way and avoid flying in the proximity of full-scale aircraft. Where necessary, an observer shall be utilized to supervise flying to avoid having models fly in the proximity of full-scale aircraft.
- 3) Where established, I will abide by the safety rules for the flying site I use, and I will not willfully and deliberately fly my models in a careless, reckless and/or dangerous manner.

5) I will not fly my model unless it is identified with my name and address or AMA number, on or in the model. Note: This does not apply to models while being flown indoors.

7) I will not operate models with pyrotechnics (any device that explodes, burns, or propels a projectile of any kind).

## Radio Control

1) I will have completed a successful radio equipment ground check before the first flight of a new or repaired model.

2) I will not fly my model aircraft in the presence of spectators until I become a qualified flier, unless assisted by an experienced helper.

3) At all flying sites a straight or curved line(s) must be established in front of which all flying takes place with the other side for spectators. Only personnel involved with flying the aircraft are allowed at or in the front of the flight line. Intentional flying behind the flight line is prohibited.

4) I will operate my model using only radio control frequencies currently allowed by the Federal Communications Commission.

5) **I will not knowingly operate my model within three miles of any pre-existing flying site except in accordance with the frequency sharing agreement listed** [in the complete AMA Safety Code].

9) Under no circumstances may a pilot or other person touch a powered model in flight; **nor should any part of the model other than the landing gear, intentionally touch the ground, except while landing.**

## CHECK LIST

During the last few moments of preparation your mind may be elsewhere anticipating the excitement of the first flight. Because of this, you may be more likely to overlook certain checks and procedures that should be performed before the model is flown. To help avoid this, a check list is provided to make sure these important areas are not overlooked. Many are covered in the instruction manual, so where appropriate, refer to the manual for complete instructions. Be sure to check the items off as they are completed (that's why it's called a *check list!*).

- 1. Check the C.G. according to the measurements provided in the manual.
- 2. Be certain the battery and receiver are securely mounted in the fuse.
- 3. If you are using a 72 MHz receiver, extend your receiver antenna and make sure it has a strain relief inside the fuselage to keep tension off the solder joint inside the receiver.
- 4. Balance your model *laterally* as explained in the instructions.

- 5. Use threadlocking compound to secure critical fasteners such as the motor screws, wheel collar SHC screws and quick connectors, etc.
- 6. Add a drop of oil to the axles so the wheels will turn freely.
- 7. Make sure all hinges are **securely** glued in place.
- 8. Reinforce holes for wood screws with thin CA where appropriate (servo mounting screws, control horn screws, etc.).
- 9. Confirm that all controls operate in the correct direction and the throws are set up according to the manual.
- 10. Make sure any servo extension cords you may have used do not interfere with other systems (servo arms, pushrods, etc.).
- 11. Balance your propeller (and spare propellers).
- 12. Tighten the propeller nut and spinner.
- 13. Place your name, address, AMA number and telephone number on or inside your model.
- 14. If you wish to photograph your model, do so before your first flight.
- 15. Range check your radio when you get to the flying field.

## FLYING

The Cosmic Wind EP is a great-flying model that flies smoothly and predictably. The Cosmic Wind EP does not, however, possess the self-recovery characteristics of a primary R/C trainer and should be flown only by experienced R/C pilots.

**CAUTION (THIS APPLIES TO ALL R/C AIRPLANES):** If, while flying, you notice an alarming or unusual sound such as a low-pitched “buzz,” this may indicate control surface *flutter*. Flutter occurs when a control surface (such as an aileron or elevator) or a flying surface (such as a wing or stab) rapidly vibrates up and down (thus causing the noise). In extreme cases, if not detected immediately, flutter can actually cause the control surface to detach or the flying surface to fail, thus causing loss of control followed by an impending crash. The best thing to do when flutter is detected is to slow the model **immediately** by reducing power, then land as soon as safely possible. Identify which surface fluttered (so the problem may be resolved) by checking all the servo grommets for deterioration or signs of vibration. Make certain all pushrod linkages are secure and free of play. If it fluttered once, under similar circumstances it will probably flutter again unless the problem is fixed. Some things which can cause flutter are; Excessive hinge gap; Not mounting control horns solidly; Poor fit of clevis pin in horn; Side-play of wire pushrods caused by large bends; Excessive free play in servo gears; Insecure servo mounting; and one of the most prevalent causes of flutter; Flying an over-powered model at excessive speeds.

## Takeoff

Before you get ready to takeoff, see how the model handles on the ground by doing a few practice runs at **low speeds** on the runway. Hold “up” elevator to keep the tail wheel on the ground. If necessary, adjust the tail wheel so the model will roll straight down the runway. If you need to calm your nerves before the maiden flight, bring the model back into the pits, peak the battery and check all fasteners and control linkages for peace of mind.

Remember to takeoff into the wind. When you’re ready, point the model straight down the runway, hold a bit of up elevator to keep the tail on the ground to maintain tail wheel steering, then gradually advance the throttle. As the model gains speed decrease up elevator allowing the tail to come off the ground. One of the most important things to remember with a tail dragger is to always be ready to apply **right** rudder to counteract motor torque. Gain as much speed as your runway and flying site will practically allow before gently applying up elevator, lifting the model into the air. At this moment it is likely that you will need to apply more right rudder to counteract motor torque. Be smooth on the elevator stick, allowing the model to establish a **gentle** climb to a safe altitude before turning into the traffic pattern.

## Flight

For reassurance and to keep an eye on other traffic, it is a good idea to have an assistant on the flight line with you. Tell him to remind you to throttle back once the plane gets to a comfortable altitude.

Take it easy with the Cosmic Wind EP for the first flight, gradually getting acquainted with it as you gain confidence. Adjust the trims to maintain straight and level flight. After flying around for a while, and while still at a safe altitude with plenty of battery, practice slow flight and execute practice landing approaches by reducing the throttle to see how the model handles at slower speeds. Add power to see how she climbs as well. Continue to fly around, executing various maneuvers and making mental notes (or having your assistant write them down) of what trim or C.G. changes may be required to fine tune the model so it flies the way you like. Mind your battery power level, but use this first flight to become familiar with your model before landing. With most electric planes it is best to have a timer set on your transmitter or a separate timer with an alarm to alert you when the battery may be getting low. This will require a few flights before determining the maximum flight time you can achieve with the batteries. This will prevent the downwind auto motor cutoff over the end of the flying field.

## Landing

To initiate a landing approach, lower the throttle while on the downwind leg. Allow the nose of the model to pitch downward to gradually bleed off altitude. Continue to lose altitude, but maintain airspeed by keeping the nose down as you turn onto the crosswind leg. Make your final turn toward the runway (into

the wind) keeping the nose down to maintain airspeed and control. Level the attitude when the model reaches the runway threshold, modulating the throttle as necessary to maintain your glide path and airspeed. If you are going to overshoot, smoothly advance the throttle (always ready on the right rudder to counteract torque) and climb out to make another attempt. When you're ready to make your landing flare and the model is a foot or so off the deck, smoothly increase up elevator until it gently touches down. Once the model is on the runway and has lost flying speed, hold up elevator to place the tail on the ground, regaining tail wheel control.

One final note about flying your model. Have a goal or flight plan in mind for **every** flight. This can be learning a new maneuver(s), improving a maneuver(s) you already know, or learning how the model behaves in certain conditions (such as on high or low rates). This is not necessarily to improve your skills (*though it is never a bad idea!*), but more importantly so you do not surprise yourself by impulsively attempting a maneuver and suddenly finding that you've run out of time, altitude or airspeed. Every maneuver should be deliberate, not impulsive. For example, if you're going to do a loop, check your altitude, mind the wind direction (anticipating rudder corrections that will be required to maintain heading), remember to throttle back at the top, and make certain you

are on the desired rates (high/low rates). A flight plan greatly reduces the chances of crashing your model just because of poor planning and impulsive moves. **Remember to think.**

***Have a ball! But always stay in control  
and fly in a safe manner.***

**GOOD LUCK AND GREAT FLYING!**

This model belongs to:

\_\_\_\_\_  
Name

\_\_\_\_\_  
Address

\_\_\_\_\_  
City, State, Zip

\_\_\_\_\_  
Phone Number

\_\_\_\_\_  
AMA Number

